

INDEX



Polo-shirts, T-shirts, Caps, Executive-wear shirts, Uniforms, Technical Coveralls, Sweaters, Neck Ties & Sets -Covering the brands PGA Tour, Slazenger, Lamborghini, Giordano, Santhome, Hans Larsen	Page: 4 - 49
Time Pieces / Watches Fashion - covering the brands Lamborghini, Balmain & Slazenger	Page: 50 - 51
IT Gadgets, Power Banks, USB Flash Memory Drives - covering the brands XDDESIGN, IDAPT, @memorii	Page: 52 - 65
Writing Instruments & Pens, including Biodegradable Pens & Pens made with Swarovski Elements - Covering the brands Balmain, Lamborghini, UMA Pens from Germany, Santhome. Platignum Pens from U.K, XDDESIGN, eco-neutral	Page: 66 - 83
Eco friendly & Biodegradable Stationery, Pens, Genuine Leather Goods, Toys & Water Bottles - Covering the brands UMA Pens from Germany & Tacx Bio -Bottles Made in Holland, eco-neutral Stationeries & Genuine Leather Goods, Little Steps from E.U.	Page: 83 - 89
Water Bottles, Mugs, Cups, Drinkware, Miscellaneous Kitchenware - Covering the brands Slazenger, Tacx Bio -Bottles Made in Holland, Hans Larsen, XDDESIGN	Page: 88 - 100
Travel Accessories & Wellness & Outdoor Articles incl. Travel Adapters, TSA Locks, Clocks, Travel Wallets, Trolley Bags, Garment Bags - Covering the brands Lamborghini, Santhome, Balmain, Swiss Peak, i Health	Page: 101 - 109
Folders (Portfolios), Organizers - Covering the brands Lamborghini, Balmain, Santhome, eco-neutral	Page: 110 - 123
All kinds of Bags - Ready Stocks & Customised incl. Laptop Bags, Briefcases, Backpacks, Messenger Bags, Trolley, Bags, Cooler Bags, Sports Bags, Travel Bags, Documents Bags - Covering the brands Santhome, Balmain, Slazenger	Page: 124 - 155
Eco-friendly Bags - Non woven, Cotton, Jute, RPET Bags - Covering the brand eco-neutral	Page: 156 - 162
Promo Clips Made in Holland	Page: 163
Keyrings & Keyholders, Stress Relievers incl. Stress Balls	Page: 164 - 166
Mouse Pads & Budget Gift Sets	Page: 167
Lanyards	Page: 168
Sunshades for Automobiles	Page: 169
Automobile Accessories From XDDESIGN	Page: 170 - 171
Customisable Diaries	Page: 172
Miscellaneous Ready Stock Articles	Page: 173 - 175
Business Card Holders & Pocket Note-Pads	Page: 176 - 178
Torches & Multi -utility Tools- covering the brands XDDESIGN, Swiss Peak	Page: 179 - 183
Calculators	Page: 181
Golf Accessories - incl. the brands PGA Tour, Santhome	Page: 184 - 185
Sporting Goods Incl. Customisable Sports Balls	Page: 186 - 187
Ladies Gifts - incl. the brands Balmain, Santhome	Page: 188 - 190
Leather Gifts - Budget / Value	Page: 191 - 195
Clocks & Desktops - Metal & Plastic	Page: 196 - 199
Quality Desktops, Desk Accessories , Desk Sets, Photo Frames, Awards, incl. Silver plated Articles - Covering the brand Lamborghini	Page: 200 - 219
Coasters	Page: 220
Gift Sets - Exclusive, High Class, incl. the brands Balmain, Lamborghini, Santhome, Platignum from U.K	Page: 221 - 263
Glossary	Page: 264 - 266
Brands available & Sound Principles of Gifts Buying.	Page: 267
Profile	Page: 268

PGA TOUR
 Polo Shirts

READY STOCK



Bamboo Navy

Bamboo Green

Ace Jacquard Polo with Bamboo

2 - Tone fabric of 65% polyester and 35% rayon nanobon.
 2 Button placket with embossed buttons. 1x1 flat knit rib collar. Necktape.
 Side slits. PGA tour print at the sleeve.
 S-XXL

NanoBon
 Is an amazing absorbent fiber because of the high quantity of micro holes. Due to strong moisture absorbency and breathability it eliminates perspiration.

Minus Ion
 The effect of this fiber will come free due to the light friction between body and air. This Minus Ion cleans the air and is considered as an "Air Vitamin"

Far Infrared Ray Effect
 This Ray comes free from the fiber and is an element of sunlight. This promotes the circulation systems in the human body and maintains a constant body temperature.

SANTHOME
 Sweaters

READY STOCK

SANTHOME



- » 100% Acrylic
- » Cashmere - like
- » Sweater for winter, autumn + spring

READY
STOCK

SLAZENGER
POLO Shirts



Navy



White



Pique knit of 100% combed cotton. GSM: 200-220. Raglan sleeves.
1 x 1 Flat knit rib collar. Contrast coloured piping on raglan sleeves.
2 Button placket with engraved tone on tone buttons.
Self fabric necktape. Slazenger embroidery on backside.
Embroidered main label at inside halfmoon.
Compliance: AZO, Formaldehyde, PCP, Uses non-carcinogenic dyestuff, APEO.



Red



Black



READY STOCK



by *Tonino Lamborghini*

100% Cotton long sleeve shirt with DuPont Teflon fabric protector. Breathable, Durable, Safe, Gentle fabric with Oil repellance & Stain resistance.

by *Tonino Lamborghini*



Grey



White



Polo Shirts- 100% cotton short sleeve
by *Tonino Lamborghini*



Navy Blue



Cream



Black

READY
STOCK

GIORDANO
Wrinkle Free
Corporate Shirts



GIORDANO wrinkle free shirts

work in comfort



breathable fabric, comfortable



wash and wear



minimal ironing



better fit, shape retention



Daily business dressing is simplified through the right choice of wrinkle free shirts.

Wrinkle free shirts are excellent everyday shirts and a smart component of the essentials stable.

Made from 100% cotton, they feature permanent creases that remain in place even after regular washing and drying. Wrinkle Free Shirts are available in full and half sleeves.

ALLDAYFRESH
 Polo Shirts

READY STOCK



Red



Deodorizer

- Stops Body Odour
- Maintains Hygiene
- Feel fresh ever
- Deodorized Using Japanese Technology

DVA

ALLDAYFRESH
 000000
DRYncool
 by
SANTHOME
 >>> ANTI-ODOUR >>> STAY FRESH <<< ALL DAY <<<

Human body sweat contains ageing smell like ammonia sulphide & body odour which results in typical odour or bad smell. This special polo uses technology that incapacitates these smell creating factors instantly. And keeps it DEODORIZED...!

Backed by leading ANTI ODOUR Specialists DAIWA, JAPAN!
 Additionally this PERFORMANCE fabric with MMS (Moisture Management System) in the special Knit Design works as excellent VENTILATION for free breathing of fabrics, making it more comfortable. That's what keeps you ALLDAYFRESH...!

READY
STOCK

Golf POLOS
Limited Edition



New



Sky Blue



Navy Blue



Anthra

This Golf Polo
Is As Distinct As Your Personality.
Enjoy The Luxurious Feel And Absolute
Comfort Of This Premium Cotton Rich Material.
In All Weather Conditions.
Play.



This garment has undergone quality checks
at all stages ensuring long lasting value to the user.

Purple -Toned Burgundy

SANTHOME
SPORTS ELEMENTS

Golf

Limited Edition

Play . In all weather conditions.

Golf Polo -Limited Edition

Premium Golf Polo in pre-dyed yarn
Quality comparable to top brands.
Collar is high quality Jacquard in yarn dyed.
Collar band and Placket in biased contrast stripes matching to body.
Premium thick trendy buttons.



DRY N COOL
Exclusive Quality
Polo Shirts

**READY
STOCK**



EDNC - Navy Blue



EDNC - White



EDNC - Black / Grey



EDNC - Red



SANTHOME
DRY N COOL



Dryncool is an advanced Moisture Management system (MMS) that helps keep the skin cooler & drier - more comfortable by transporting sweat to outer layer. Premium Quality Heavier than BDNC Polo.No fuss Performance. Creaseless. Contrast tape on button placket.Contrast neck tape.Highlighting style. Authentic MMS logo. Embossed buttons.

READY STOCK

DRY N COOL
 Polo with Stripes



SDNC - Black / White Stripes



SDNC - White / Blue Stripes

SANTHOME
 DRYNCOOL

DRY N COOL Basic polo with a touch of elegance by adding woven stripes around the neckband & placket.

READY STOCK

DRY N COOL
 V-Neck Style Wear Polo



VDNC - Cream



VDNC - White

000000
DRY ncool
 BEST COMFORT

DRY N COOL Basic polo with a touch of elegance.
 Regular shorter collar that can go inside V Neck.
 Smart V Neck With Light Contrast Tipping.

DRY N COOL
 Basic Polo

READY STOCK



BDNC - Red



BDNC - Green



BDNC - Charcol Grey



BDNC - Grey Melange



BDNC - Royal Blue



BDNC - Navy Blue



BDNC - Black

SANTHOME
 DRYNCOOL

by
SELECT
 Since 1989

DRY mcool
 BEST COMFORT

BDNC - White

SANTHOME
 DRYNCOOL

SIZE (M)

30°C

WASH COLOURED GARMENTS SEPARATELY
 DO NOT IRON ON PRINTS, EMBELLISHMENTS

MADE IN INDIA

MMS
 MOISTURE MANAGEMENT SYSTEM

Dryncool is an advanced Moisture Management system (MMS) that helps keep the skin cooler & drier - more comfortable by transporting sweat to outer layer executive wear. Premium quality. No-fuss performance. Creaseless. Well knit collar & cuff for stability, Inverse placket for more than basic look, buttons are embossed Santhome, side slits have bartack, inside facing of fabric is textured for optimum sweat absorbency.

READY STOCK

**Exclusive Quality
 2ply 100% Cotton
 Polo Shirt**



Olive Green



Royal Blue



Orange



Ash Melange



Yellow



Navy Blue

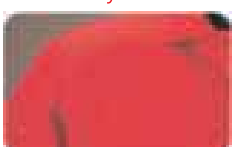

Red



White/Red



Black



Sky Blue

White



SANTHOME
 BY
SELECT
 Since 1989

MACY:
 100% cotton. 260 GSM 2 ply super combed pique polo shirt.
 Premium quality comparable to top brands.
 Performance for colour fastness, shrinkage and shape retention - wash after wash.
 Well knit collar and cuff for stability,
 smart buttons, side slits for added comfort.

Exclusive Quality
 2ply 100% Cotton
 REGLAN Polo Shirt

READY
 STOCK



White- Royal Blue



White-Red



White-Navy Blue



White-Green

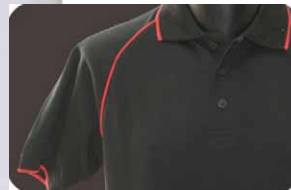

Black-Red



White-Royal Blue



Blue-Beige



White-Black



White-Orange

SANTHOME

BY

SELECT
 Since 1989

REGLAN:

100% cotton. 260 GSM 2 ply super combed pique polo.. ie. same as MACY fabric.

Trendy Executive Wear. Premium quality comparable to brands. Performance for colour fastness, shrinkage and shape retention. Collar/cuff has contrast tipping. Reglan sleeves has contrast piping.

READY STOCK

Regular Polo Shirt



Sky Blue

All New Combos!



Grey Melange - Navy Blue



Black-Red



White-Green



White-Navy Blue



White-Red



White-Black



White-Orange



White-Royal Blue



SAILOR
 BY
SELECT Since 1989

SAILOR:
 100% Cotton 215-220 gsm pique polo shirt in Budget price range. With self tipping collar and cuff. NEW styles come with contrast collar and cuff. Best for mass distribution at budget price.

READY STOCK



White

Interlock Drop Needle Polo Shirts- Soft Quality Comfort

SANTHOME
 BY
SELECT
 Since 1989

INTERLOCK DROP NEEDLE POLO SHIRTS :
 100% Combed Cotton 240-250 gsm fabric in Interlock drop needle knit. This knit structure gives a very soft and luxurious feel. The Jacquard collar and cuff with fake horn buttons give a very classy look. Value-for-money polo for every type of use.

BIO - ONE80
 Quality T- Shirts

READY STOCK



Royal blue



Black



Orange



White



Red



Ash melange



Navy blue



Petrol



BIOOne80
 by
SANTHOME

This PREMIUM cotton T shirt uses high quality LONG STAPLE cotton from Central India. This ensures superior consistency of the yarn it is spun from. Resultant fabric knitted shows the rich handfeel and luxury of COTTON we love. BIO process adds further to the smooth and soft luxury one would never want to come out of ...!

180 GSM.

READY STOCK



Pink



Maroon



Yellow



Grey Melange



Royal Blue



Orange



Navy Blue



E-Green



Sky Blue



White



B-Green



Black



Beige

Red

ORIGINAL
SELECT
QUALITY

100% cotton, 180 gsm Quality Ready stocks available for mass distribution in various colors.

Real Silk Ties

Silk Ties - Exclusive Packaging

100% Pure silk HANS LARSEN branded tie in an exclusive pure silk covered box.
 Also available sets of tie + handkerchief. Assorted models available.



T 017



T 005



T 004



T 024



T 015



T 025



High Quality Tie & Handkerchief Set in Box Packing

Every microfibre tie comes with matching kerchief, in tin box packing, with tie material wrapped on the box as shown below; a desirable gift set!

SANTHOMÉ

102



126



121



112



108



123



107



129





Every microfibre tie comes with matching kerchief, in tin box packing, with tie material

SANTHOME wrapped on the box as shown below; a desirable gift set!

105



117



111



104



130



113



109



116



106



103



124



110



Slazenger
 6 Panel Cool Fit Cap



Formaldehyde-compliant
 AZO - compliant



White/Navy Blue sandwich



Black/White sandwich

SANTHOME
 Performance / Sports Caps



SC 101 White/Red



SC 101 White/Pink



SC 101 White/Navy Blue



SC 101 White/Maroon



SC 101 White/Royal Blue



The exclusive quality caps carry this **SANTHOME** logo
 'de Genève'



SANTHOME Deluxe pique mesh spandex fitted cap



- » SANTHOME logo spandex sweat band.
- » 100% Poly deluxe pique mesh.
- » Buckram & pre-curved sandwich bill.
- » High quality equivalent of top brands.



Navy blue/White sandwich



Black/White sandwich



Cream/Black sandwich



Red/Black sandwich

High Quality
 Heavy Brushed
 Cotton Caps

Ready
 Stock



Black



Khaki



Light Grey with
 Navy blue peak
 and Grey sandwich



Pink with
 Purple sandwich



Cream with
 Maroon sandwich



Navy Blue with
 Grey sandwich



White with
 Black sandwich



Orange with
 Black sandwich



Grey



White



Khaki with
 Maroon sandwich



Black with
 Grey sandwich



Black with Red sandwich



Maroon



Navy Blue



White with
 Royal Blue sandwich



Bottle Green



Red with
 White sandwich



Cream

100% Heavy brushed cotton
 cap with metal buckle



The best quality caps carry this
Hans Larsen logo



Emerati Green



Purple



Maroon



Red



Royal Blue



Sky Blue



White



Orange



D. Green



Grey



White with Navy blue peak



White with Black peak



White with Red peak



White with Green peak



White with Maroon peak



White with Green peak



White with Royal blue peak



Maroon with White peak



Black



Golden Yellow



Beige



Navy Blue



Sunvisor Red

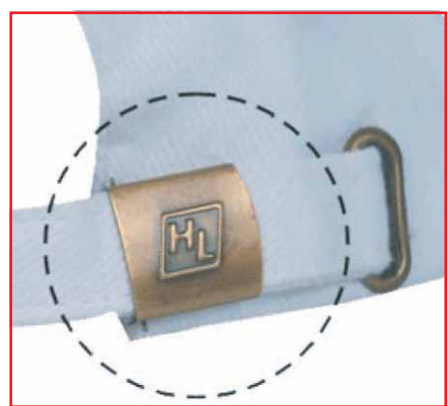

Look for this "HL" logo

100% Heavy brushed cotton cap with metal buckle



Hans Larsen
SPORTSMAN



White / Royal Blue sandwich



White / Red sandwich



White / Maroon sandwich



White / Navy Blue sandwich



Black / Red sandwich



Black / Orange sandwich



Black / Grey sandwich



Navy / Red sandwich



Navy Blue / Grey sandwich

DIY (Design It Yourself) Customization

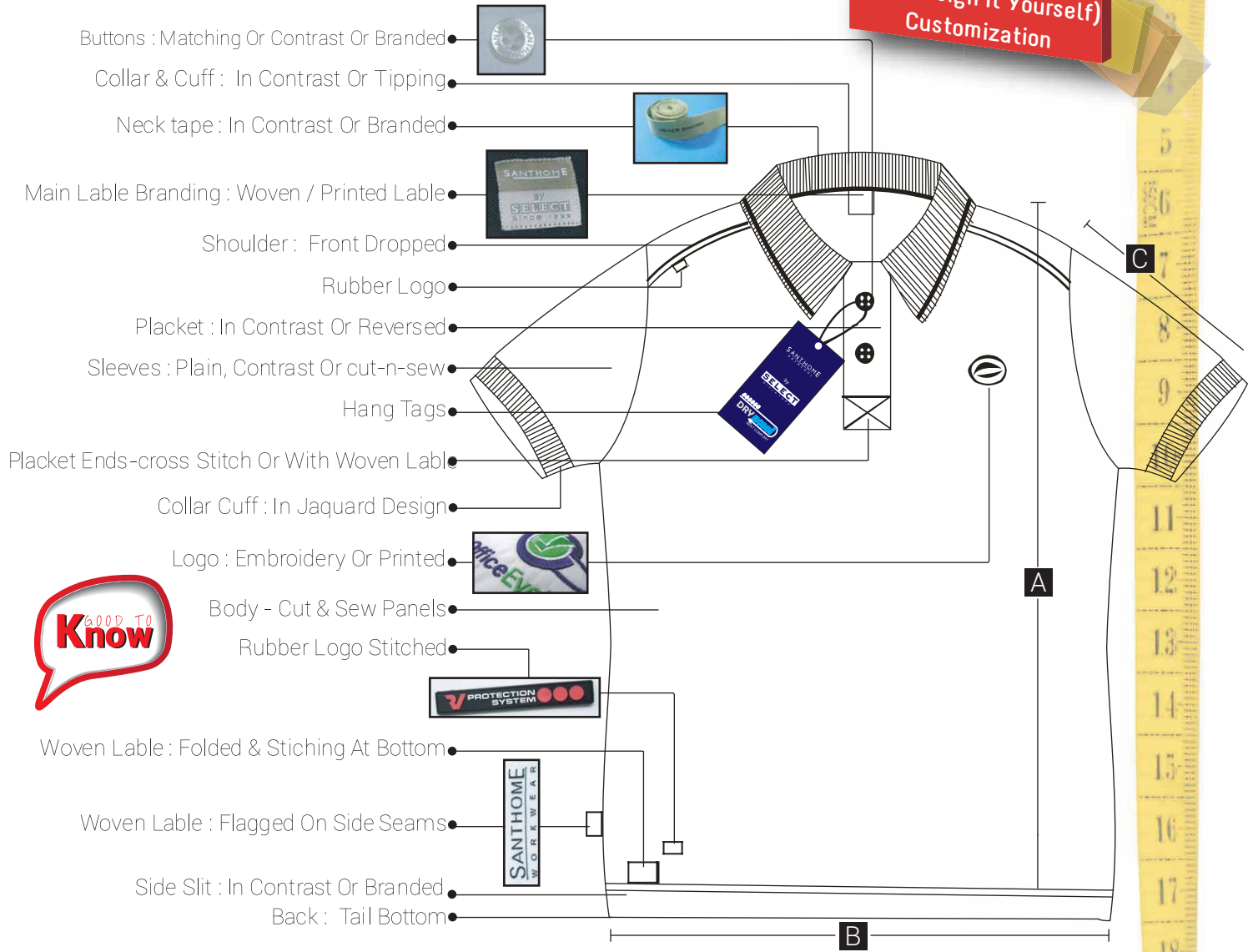

Typical measurements:-

	Gulf/Asian Sizes			Europe Sizes		
	M	L	XL	M	L	XL
A	27	28	29	29	30	31
B	21	22	23	22	23	24
C	8	8.5	9	8.5	9	9.5

These measurements are for guidelines only. The actual measurements may vary slightly between garments as knit garments have internationally accepted higher tolerance values

GSM or GMS ?

Most manufacturers confuse clients with this. GSM: Grammes per sq. meter is the wt. of the fabric in a square of 1 meter x 1 meter. it remains the same in all sizes. Hence the correct way to describe GMS: is the wt. in grammes per piece of the Tee/Polo And will always vary with each size. Thus, completely misleading. We ALWAYS specify the GSM. So you are rest assured of what we offer.

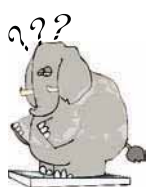
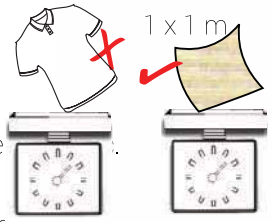

Heavier the better ?

Not necessarily. The quality of yarn will decide the quality and Price. Super combed, combed, semi combed and carded: this is the quality of YARN in descending order. We specify the yarn. So you are rest assured of what we offer.

What more we can offer:

You Are Welcome To Send Your Design Ideas And Originals. We Will Reproduce It For You..!

Trendy wear
Customized



Sapil



Italia ladies



Carrier



Toyota



Trendy wear
Customized



OYRC



Ambro



Picaso collar



Golf polo - 2tone



Golf Polo - Picaso

Trendy wear
Customized



Orange



Lemon



White-Lemon



White-Orange



Green



Printed Bubbles

Trendy wear
Customized



Array



Customized Safety Coverall
Fire Retardant - PYROVATEX

SANTHOME WORKWEAR PYROVATEX®

Integrity • Efficiency • Reliability
SELECT
Since 1980



SANTHOME WORKWEAR PYROVATEX is a treated fabric that offers good protection against flames.

These are treated on fabrics made from cotton, Polycot and other cotton blends. Although treated, it lasts for at least 50 washes.

Thus it is an economical way of getting the protection.

These fabrics could also be added with ANTI-STATIC,

Water/oil repellence properties.

SANTHOME WORKWEAR comes with

OEKO TEX 100 Standard which uses

ECO FRIENDLY DYEING standards

(Free from Harmful Substances in Dyeing,

hence eco and skin Friendly!).



EN 471



EN ISO 11612
A1 B1 C1

Stds compliant to:

EN ISO 11612, EN ISO 11611, EN ISO 14116,

EN ISO 61482, EN ISO 1149, etc.

Specifications:

2 chest pockets with flap velcro closure.

#5 YKK Golden Brass 2 Way zippers.

Collar closure with metal snaps.

2 cross pockets in front below waist line.

One patch pocket at back. Reflective tapes.

Colours: Petrol Blue (light blue), Navy, Khaki,

Orange, Red, Yellow, Grey.

Certifications



SANTHOME
 WORKWEAR
 DuPont™
NOMEX® IIIA

Customized Safety Coverall
 Fire Retardant - NOMEX



SANTHOME WORKWEAR NOMEX, NOMEX IIIA, DELTA C, etc.

have excellent Fire protective property.

The NOMEX fiber is itself inherently flame resistant. This can not be washed or dry cleaned out of the Nomex fiber and therefore stays the life of the garment.

Nomex will not burn in air like a cotton fabric and will not melt and drip like a polyester fabric. When exposed to a flame source Nomex absorbs the heat energy and the fiber will swell up, thickening in the process which in turn helps to stop heat transfer to the individual person.

The addition of 5% Kevlar also helps establish Nomex IIIA having a better abrasive resistant factor and longer garment life compared to FR Cotton fabrics.



EN 471



EN ISO 11612
 A1 B1 C1

Std's compliant to:
 EN ISO 11612, EN ISO 14116, EN ISO 61482,
 EN ISO 1149, NF PA 70E, NFPA 2112, etc.

Specifications:

2 chest pockets with YKK brass zipper closure pockets.

#5 YKK Golden Brass 2 Way zippers. Collar closure with metal snaps.

2 cross pockets in front below waist line.

One patch pocket at back.

Colours: Petrol Blue (light blue), Navy, Khaki, Orange, Red, Yellow, Grey.

Certifications



Customized Safety Coverall
Fire Retardant - PROBAN



Integrity • Efficiency • Reliability
SELECT
Since 1980



SANTHOME WORKWEAR PROBAN is a treated FR fabric with excellent protective property. Using Cotton and cotton-rich fabrics, it lasts over 50 washes. PROBAN treated fabrics do not smoulder, have no afterglow and the flame does not spread outside the charred area, unlike other flame retardant systems. PROBAN treated fabric do not melt away to form a hole through which flame can penetrate through nor they form a sticky residue which can adhere to the skin of the wearer. Thus it is very effective in protection.



EN 471



EN ISO 11612
A1 B1 C1

Stds complaint to:
EN ISO 11612, EN ISO 11611, EN ISO 14116,
NFPA 2112, ASTM F 1506.

Comfort and ergonomics meet EN 340 standards.

SANTHOME WORKWEAR comes with OEKO TEX 100 Standard which uses ECO FRIENDLY DYEING standards (Free from Harmful Substances in Dyeing, hence eco and skin Friendly!).

Specifications:

2 chest pockets with flap velcro closure.

#5 YKK Golden Brass 2 Way zippers.

Collar closure with metal snaps. 2 cross pockets in front below waist line.

One patch pocket at back. Reflective tapes.

Colours: Petrol Blue (light blue), Navy, Khaki, Orange, Red, Yellow, Grey.

Certifications





Customized Safety Coverall
Fire Retardant - PROTEX



SANTHOME WORKWEAR PROTEX is an inherently FR fabric.

This means that it lasts for the whole life of the fabric.

Mixed with cotton in a combination of 55% Protex/45% Cotton, gives it excellent drape, appearance, feel. With different GSMs

we can make it meet different levels of protection.

It can also be produced in fluorescent colours for

Hi-Vis applications and with reflective tapes.



EN ISO 11612
A1 B1 C1

Stds compliant to:

EN ISO 11612, EN ISO 61482, EN ISO 1149,

NFPA 70E, NFPA 2112, EN 13034, etc.

Comfort and ergonomics meet **EN 340 standards.**

SANTHOME WORKWEAR comes with OEKO TEX 100 Standard which uses ECO FRIENDLY DYEING standards

(Free from Harmful Substances in Dyeing, hence eco and skin Friendly!).

Specifications:

2 chest pockets with YKK brass zipper closure pockets.

#5 YKK Golden Brass 2 Way zippers. Collar closure with metal snaps.

2 cross pockets in front below waist line. One patch pocket at back.

Colours: Petrol Blue (light blue), Navy, Khaki, Orange, Red, Yellow, Grey.

Certifications



Basic Coveralls
 Customized

SANTHOME
 WORKWEAR



EN 471

SANTHOME WORKWEAR are ideal for Factories, Workshops, WH handling, etc. where quality, comfort and performance matter most. It can also be produced in fluorescent colours for Hi-Vis applications and with reflective tapes. High quality of workmanship and accessories lasts the life of garment, helping optimize uniforms' use and thus costs. Comfort and ergonomics meet EN 340 and Safety meets EN 471.

SANTHOME WORKWEAR comes with OEKO TEX 100 Standard which uses ECO FRIENDLY DYEING standards (Free from Harmful Substances in Dyeing, hence eco and skin Friendly!).

Specifications:

2 chest pockets with CFC zipper closure pockets. Collar closure with metal snaps.
 2 cross pockets in front below waist line. One patch pocket at back.

Colours: Petrol Blue (light blue), Navy, Khaki, Orange, Red, Yellow, Grey.



SANTHOME
 WORKWEAR
PYROVATEX®

Fire Retardant
 Customized
 Work Wear



protex FR trousers



EN ISO 11612
 A1 B1 C1



FR shirt

SANTHOME WORKWEAR PYROVATEX Fire Retardant (FR) fabrics are also used in making FR Protected trousers and shirts. Trousers are with high quality stitching with double needle stitches at all seams. The waist band has inside grip so that the shirt stays inserted even during heavy work conditions. All stress points are bartacked

SANTHOME
 WORKWEAR



Polo with TAURUS reflective tape configuration

Reflective clothing for safety at work. For Construction sites, transport cos., WH handling, etc.



T shirt with VIRGO reflective tape configuration.



EN 471



Shield

Reflective Vests.



Armour

Coveralls For Workshops Customized

SANTHOME
WORKWEAR

Integrity • Efficiency • Reliability
SELECT
Since 1980



SANTHOME WORKWEAR are customized for Workshops and showrooms as smart outfits meeting exacting stds of quality and performance. The option # RIBB has knitted ribs at cuffs and bottom ends for comfort and styling. # PADDY has provision for knee pads for extra protection at work. 100% cotton or polycot fabric will meet client requirements of comfort and utility. Ergonomics and measurements of the coveralls meet EN 340 standards.

Work Wear
Customized

BROOKLYN Shirt in 100% cotton twill has excellent resilience to every day wash and wear. Two patch pockets with button through flaps on front and a pen slot on sleeves. Epaulets on shoulder. Ideal for drivers and as Security uniforms. Co-ordinated ELTON cargo Pants in 100% cotton Chinos are a smart uniform for staff.



Brooklyn shirt

Elton cargo pant



TwillCargo Shorts

100% cotton TwillCargo Shorts are ideal for working in the hot and humid climate of the region. The branding can be done on the side pocket flaps.



Denim pant

100% cotton Denim Pants are best for work. The long lasting denim (Jeans, as called popularly) will become more comfortable with every wash.

Work Wear
Customized

SANTHOME
WORKWEAR



Rave

RAVE Messenger Uniforms Set:
180 gsm, 100% cotton Stylish
Biased panel Johnny collar polo
with 100% cotton Khaki cargo pants.
Smart uniforms that will also deliver
your identity!



Fattorino

FATTORINO Messenger Uniforms Set :
Polycot Multi panel shirt with black Polycot trousers.
Smart uniforms that will also deliver your identity!



Bullet

UBA Smart Shirts: High quality cotton or Polycot shirts with cut and sew panels making smart uniform options.



UBA-1



UBA-2



UBA-3

Bullet : 100% cotton Twill. Graphics printed panels on front, sides and back. Bottom opening with ribs! Trendy styles with comfort in mind. Astronaut collars. Reflective tapes on sleeves. Padded knee area.



EN STANDARDS OF PROTECTION & SAFETY (PPE)

SPECS	LIMITED FLAME SPREAD (ISO 9151:1995)	CONVECTIVE HEAT (EN ISO 15025:2002)	RADIANT HEAT (EN ISO 6942:2002)	MOLTEN IRON SPLASH (EN ISO 9185:2007)	ELECTROSTATIC DISSIPATIVE BEHAVIOUR (EN 1149:2008)	PROTECTION AGAINST WELDING*	HIGH VISIBILITY WARNING (EN 471:2003 A1:2007)	ARC THERMAL RESISTANCE (EN 61482-1-2)
MATERIAL								
100% COTTON PYROVATEX FR								
Cotton 220 GSM Drill	A1	B1	C1	-	-	-	-	-
Cotton 350 GSM Drill	A1	B1	C1	E3	-	CLASS 2 - A1	-	CLASS 1
Cotton 220 GSM Antistatic	A1	B1	C1	-	✓	-	-	-
Cotton Hi-Vis Antistatic 320 GSM	A1	B1	C1	-	✓	-	✓	-
ARAMID AND ARAMID BLENDED FABRICS (NOMEX, KAVLAR)								
FR ANTISTATIC 150 GSM	A1	B1	C1	-	✓	-	-	-
FR ANTISTATIC 210 GSM	A1	B1	C1	-	✓	-	-	-
FR ANTISTATIC 270 GSM	A1	B1	C1	-	✓	-	-	-
FR 150 GSM	A1	B1	C1	-	-	-	-	-
FR 260 GSM	A1	B1	C1	-	-	-	-	-
MODACRYLIC (PROTEX)								
FR HIGH VISIBILITY 250 GSM	A1	B1	C1	-	-	-	✓	-
FR ANTISTATIC 180 GSM	A1	B1	C1	-	✓	-	-	-
FR ANTISTATIC 250 GSM	A1	B1	C1	-	✓	-	-	-

*(EN 11611:2007 Impact Of Spatter as per EN 9150)

REVISED FLAME RETARDANT NORMS

TEST PARAMETER	EN 531 (Old)	EN ISO 11612 (New)
General Information		
HEAT RESISTANCE SHRINKAGE - at 180 °C (ISO 17493)	NOT REQUIRED	Fabrics/Hardware shall not ignite/melt. Shrinkage ≤ 5%
FLAME SPREAD Procedure A - Surface Ignition	No further flaming or hole formation No flaming, Melting Debris After Flame Time ≤ 2 sec After Glow Time ≤ 2 sec	Unchanged Unchanged Unchanged Unchanged
SEAMS	NOT REQUIRED	Shall remain Intact
FLAME SPREAD (Optional) - (EN ISO 15025) Procedure B - Edge Ignition	NOT REQUIRED	Same as Procedure A
DIMENSIONAL CHANGE (ISO 5077)	Woven: ≤ 3% & Knits: ≤ 5%	Unchanged
TENSILE STRENGTH (ISO 13934-1)	NOT REQUIRED	≥ 300 Newtons
TEAR STRENGTH (ISO 13937-2)	NOT REQUIRED	≥ 15 Newtons
BURSTING STRENGTH FOR KNITTED MATERIAL (ISO 13938-1)	NOT REQUIRED	≥ 200 kPa
SEAM STRENGTH (ISO 13935-2)	NOT REQUIRED	≥ 225 Newtons
Heat Transfer Performance Requirements		
CONVECTIVE HEAT - CODE B (ISO 9151)	CODE B1 - 3 sec to 6 sec CODE B2 - 7 sec to 12 sec CODE B3 - 13 sec to 20 sec CODE B4 - 21 sec to 30 sec CODE B5 ≥ 31 sec	LEVEL B1 ≥ 4 sec < 10 sec LEVEL B2 ≥ 10 sec < 20 sec LEVEL B3 ≥ 20 sec
HEAT RADIATION - CODE C (ISO 6942) Heat Flux Density = 20 kW/m ²	CODE C1 - 8 sec to 30 sec CODE C2 - 31 sec to 90 sec CODE C3 - 91 sec to 150 sec CODE C4 ≥ 151 sec	LEVEL C1 ≥ 7 sec < 20 sec LEVEL C2 ≥ 20 sec < 50 sec LEVEL C3 = 50 sec < 95 sec LEVEL C4 ≥ 95 sec
MOLTEN ALUMINIUM SPLASH - CODE D (ISO 9185)	CODE D1 - 100 g to 200 g CODE D2 - 201 g to 350 g CODE D3 ≥ 351 g	Unchanged Unchanged Unchanged
MOLTEN IRON SPLASH - CODE E (ISO 9185)	CODE E1 - 60 g to 120 g CODE E2 - 121 g to 200 g CODE E3 ≥ 201 g	Unchanged Unchanged Unchanged
CONTACT HEAT at 250 °C (ISO 12127)		LEVEL F1 ≥ 5 sec < 10 sec LEVEL F2 ≥ 10 sec < 15 sec LEVEL F3 ≥ 15 sec

School & University
Uniforms



Varsity jacket



Aisj Polo



hoody



graduation day



Aisj PE tee and shorts.



Nursery polo

High quality School uniforms for International American and European Schools. Shirts and shorts from BDNC fabric, PE tees from BIO180, Hoodies from Premium Polycot brushed/unbrushed fleece, Varsity jackets from glaze micro poly and shiny polysatin for the graduation day. Nursery polos from Premium Dryncool Enriched cotton for comfort of the tiny ones!

Active Wear
Customized



Ladies sports track set



Burkini



Storm



S-force



Victory

Active Wear
Customized



Cricket set



Basket ball set



Cycling tee (front)



Cycling tee (back)

Active Wear
Customized



Topper



Leader



Winner



Referee



Triumph

**Formal wear
 Customized**



Men's Solid shirt



stripes formal shirt



checks formal shirt



Oxford Ladies shirt



Regular fit pleatless PV trouser



Comfort fit Pleated trousers

Formal shirts and trousers in various colours, fabric qualities, designs can be made customized to the need of the industry. Shirts come in Plains, Checks (plaids), Stripes and Oxfords. Trousers come in PV, PC, Cotton and other blends. Fit options of shirts like slim fit, comfort fit and relax fits along with trousers having narrow, regular, pleated, pleatless are possible. All trousers come with inside waist grip for shirts.

Formal modern fit PV pleated trousers

Hospitality Uniforms
Customized

SANTHOME
WORKWEAR

Integrity • Efficiency • Reliability
SELECT
Since 1989

CHEF UNIFORMS



Executive



Master



Chieftan

D'luxe

Vests

Hospitality Uniforms
Customized



Felix



Carlos



Jacky



Spa Uniform



Facilities Uniforms



Apron

Every type of uniforms can be made for Hotels and the Hospitality Industry. Ensuring high quality of workmanship and fabrics.

**Winter Jackets
Customized**



DCA jacket

100% cotton twill reporter jacket with various pockets for multiple use.



Cnaq Jacket

Sleeveless jacket in polar fleece with 2 front and full opening zippers. High neck collars when zippers are pulled up.



Sailing jacket

Sleeveless jackets with turn-up collar. Lined with polar fleece for light winter comfort.



Adike

Polycot one side brushed sweat shirt with contrast piping on shoulder and ribs on cuff and bottom.

Winter Jackets Customized



Varsity jacket

Shiny polyester outer with matching striped ribs on cuff, collar and bottom is a perfect jacket for students and others, alike. PolyMesh lined for comfort and style. Large bold decoration by embroidery.



Urban Jacket

100% polyester soft micro jacket with fleece lining are ideal for light winters in an urban environment.



Heavy Jacket

100% heavy polyester soft micro jacket with multiple pockets with zipper and snap button opening. Long jackets. Lined with heavy fleece. Subtle contrasts make it trendy and functional.



Sony jacket

100% micro polyester simple tefetta lined jacket. Snap button closures. Original YKK zippers add value to the performance and quality.

Tonino Lamborghini Fashion



by *Tonino Lamborghini*

Ready Stock



VARESE - 98056-50
 Men's high quality split leather belt,
 Metal buckle.



VERIMELLI - 13117B
 Metal / Leather Keyring

SLAZENGER Fashion



- » Confirms to Battery Directive
- » WEEE-compliant
- » EMC-compliant

Ready Stock



SG 801
 Slazenger sunglasses
 with Carbon Fiber Finish



Slazenger Digital sports watch has many functions like
 water resistance, alarm, time, date, stopwatch
 and back light in transparent gift box.
 6.7 x 10 x 7.3 cm

BALMAIN Umbrella

BALMAIN
 PARIS

Ready Stock



UI 1231
BALMAIN 21" 3-SECTION UMBRELLA
 3-section umbrella with contrasting edge and
 the handle is with an imitation leather finishing.
 95 x 25.5 cm



by *Tonino Lamborghini*

**Tonino Lamborghini
Time Pieces**



REI - 98100

Automatic watch,
stainless steel case and strap,
10 ATM, mineral glass.

**Ready
Stock**



TROPEA- 98181-19

Ladies watch, with
stainless steel case and strap,
Mother of Pearl dial, Japan movement.



PUGLIA - 98189-10

Analogue watch with
stainless steel case, 5 ATM,
PU strap, Japan movement.



VICOLO - 98180-10

Analogue watch with
stainless steel case, 3 ATM,
leather strap, Japan movement.



A bunch of flowers is always a good gesture, one that is highly appreciated, and Sunshine especially! Sunshine prefers a well lit spot in the center of any home or office. Requires no watering, but is fond of recharging mobile phones !



XD | ECO

Designed by :



Antoine
France



UD 775

XDDESIGN® Sunshine is the bunch of flowers that fits every desk or household. Due to its unique Resound® material combination and the 5 integrated solar panels it's a very sustainable gift. The 2600mAh rechargeable lithium battery will make sure you can store all that energy and pass it through to your mobile device whether it's a phone or a tablet. Including a Micro USB cable. Registered design®.

With brushed metal plate base, USB output(5V/1.2A) Micro USB input(5V/500mA) and 2 indicator lights on one side, 5pcs flexible plastic wires connect with solar panel flowers. Built-in 2600mah Li-battery, comes with a Micro USB charging cable, manual and 1 Li-ion battery. RoHS / CE / FCC / WEEE / Battery compliant. Made from 45% bio-based material derived from plants, not oil resulting in carbon footprint reduction.



XDDESIGN®

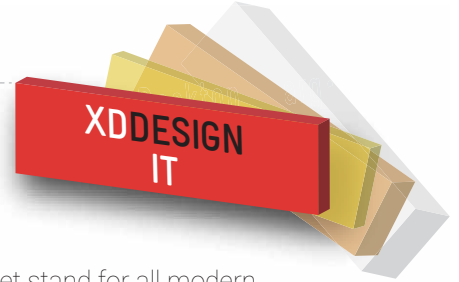

DT 610

XDDESIGN® Chef is the tablet stand for all modern and creative chefs. The sturdy touch pen makes it easy to use your tablet under steamy kitchen circumstances without leaving any traces of food on your tablet. Registered design®

Designed by :



Antoine France



Ready Stock

UD 774

XDDESIGN® Port is the ideal Mobile Solar Charger with embedded USB port. Due to the integrated suction pad it can be attached to any window, whether it's at home, in the car or on the plane. You are backed up by an internal 1000 mAh rechargeable lithium battery which brings your stored sun-power wherever you go. Registered design®

ABS case executed in silver sprayed rim with gloss white front cover, 5 LED indicator and white capacity check button on top, integrated with black USB input cable and USB output socket (5V/800mah). Transparent PVC suction pad and black solar dipping panel on back, built-in in 1000mAh Li battery, Including manual and 1 Li-ion battery. RoHS / CE / FCC / WEEE / Battery compliant.

Designed by :



Ryan McSorley
Ireland



XD | ECO



Ready Stock

Universal Power Banks



Black / Silver



UD 748

Portable Universal Charger - Power storage device that comes with 4 adaptors (Apple products, micro USB, mini USB and female USB). Charges your devices on the go and is portable for travel use.

Capacity: 3100 mAh. Dimensions: 100 x 63 x 37 mm



White/ Silver



UD 783 - Battery capacity : 5000 mAh

Elegant Power Bank comes in a metal exoskeleton. It can support a range of products including iPhones, GPS devices, mobile phones, iPads, cameras, bluetooth devices, mp3, mp4 and other electronics.

UD 784 - Battery capacity : 8000 mAh



UD 780
Solar Charger Power Bank - High Quality Solar Power Bank equipped with a high grade Li battery. Supports iPhones, smartphones, iPads, cameras, GPS devices, mp3, mp4 and other electronic devices. Battery capacity: 2000 mAh



UD 781
Chic Credit Card Power Bank
This sleek power bank is 6mm thick Supports iPhones, smartphones, iPads, cameras, GPS devices, mp3, mp4 and other electronic devices. Battery capacity: 1500 mAh



UD 773
Multi-Functional Rotational Car Charger
This device is a 3-in-1 car charger + power bank + torch. Supports iPhones, smartphones, iPads, cameras, GPS devices, mp3, mp4 and other electronic devices. Perfect for travel, especially on road trips. Battery capacity: 1400 mAh

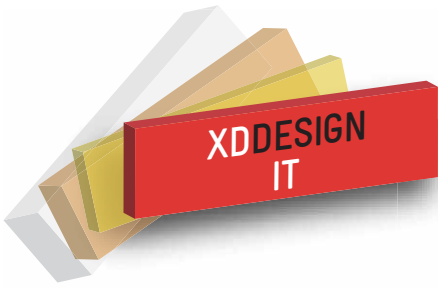

XDDESIGN[®]

Designed by:



Ryan McSorley
Ireland



XD | ECO



UD 782

XDDESIGN[®] Suntree uses 9 solar leaves to charge your mobile phone or MP3 player using solar cell technology. A real eye catcher for any desk, with a powerful 1350mAh rechargeable lithium battery inside. The solar charger has an USB output and mini-USB input. Including a mini USB cable. Registered design[®]





Designed by:
 Luke Burley
 England



Black



Blue



Pink

UD 779

XDDESIGN® Eddy is your Flexible Phone Friend in all circumstances
 Registered design®
 Flexible fingers to hold the phone in every angle and complete comfort



UI 1264

PU Leather Ipad Case
 (Pen is not included)



UD 708

Aroma Dispenser
 With logo area- A USB flash drive without memory? Yes, ready stocks available of ready-to-use USB fragrance dispenser with fragrance refill.

IDAPT SPAIN
 Desktop Chargers

No More Cables

Ready Stock



ED 447

InnovativeAdapter
IDAPT[®]



i2P
 Universal
 Charger

COMPATIBLE WITH
4500+
 GADGETS



Universal

Specifications
 worldwide compatibility
 AC Input: 100/240V /
 50/60 Hz 0.35A
 2 independents chargers

2 points the charge
 cord length: 1,6 m
 Size: 135 x 123 x 34
 Weight: 225 grams

**The Only
 Charger
 You Need**

**Ready
 Stock**

ED 448

i3P
 Universal
 Charger



Specifications
 worldwide compatibility
 AC Input: 100/240V /
 50/60 Hz 0.35A
 2 independents chargers

2 points the charge
 cord length: 1,6 m
 Size: 135 x 123 x 34
 Weight: 225 grams

**Charge
 All Your
 Devices**

**SIMULTANEOUS CHARGING
 FOR UP TO 3 DEVICES**



IDAPT IS SUBJECT TO PATENTS AND REGISTERED TRADEMARKS.
 COPYRIGHTS © 2006-2011 INOITULOS. ALL RIGHT RESERVED. ASSEMBLED IN P.R.C. NAMED BRANDS OWNED BY THEIR CORRESPONDING CORPORATIONS.
 DEVICES ARE SHOWN FOR ILLUSTRATION PURPOSES ONLY AND ARE NOT INCLUDED.

InnovativeAdapter
IDAPT[®]



UD 702
 Wireless USB Drive Mouse, Receiver with USB Drive Function,
 USB Drive part with 2 GB / 4GB. In Deluxe Gift Box



UD 713
 Phone Charger Hub
 Convenient mobile placement with mobile charger function
 (5 common Connectors included)
 3 Port USB Hub 'Antenna' style pen with built in stand
 Convenient Desktop Model



White

ED 445

Stereo Speakers for smartphones and computers with desktop design. Ability to dock smartphones. When connected, these light up. Dimensions: 125 x 98 x 80 mm



Black



ED440
 Portable speaker with built in cable, audio & USB plug. Speaker head is movable, built in lithium li-on rechargeble battery. 60mm diameter & 60mm height.

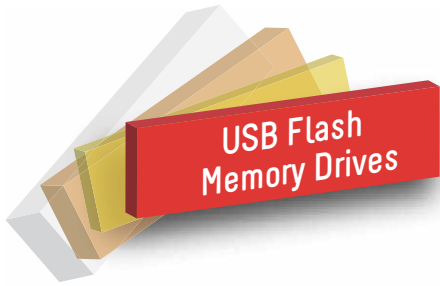

Available
in 2, 4, 8, 16, 32 GB
memory
capacity

UD 751

A twister with a difference, unique flat and sharp design gives this USB a modern and trendy appearance



Silver Black



Silver Maroon



Silver Kuwait Blue



Silver Red



Silver Royal Blue



Full Black



Black Red



Black Kuwait Blue



Black Maroon

with original SAMSUNG chipset @MEMORii

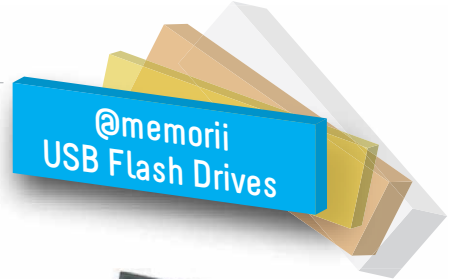

UD 760
 Sliding USB chip with a useful key chain and excellent logo space



UD 703
 USB Flash drive all in one set detachable USB flash drive, version 2, with business card case & pen. In deluxe gift box. Card case with aluminium top cover



UD 703 L
 USB Flash drive all in one set detachable USB flash drive, version 2, with business card case & pen. In deluxe gift box. Card case is elegantly coated with leather.

Available
 in 2, 4, 8, 16, 32 GB
 memory
 capacity



UD 762
 Italian design and German precision engineering have come together to produce this unique designer model; a high end model



UD 761
 As you swivel the body, the chip moves out

USB Flash Drives

Available
in 2, 4, 8, 16, 32 GB
memory
capacity

**Ready
Stock**



UD 764
Wrist band USB Flash Drive



UD 765
Wrist strap-on /snap-on
USB flash drive



**Metal USB
Flash Drives**

Available
in 2, 4, 8, 16, 32 GB
memory
capacity

**Ready
Stock**



UD 728
Metal USB Flash Drive
with Keyring



UD 757
Metal USB Flash Drive
with key ring



UD 723
Metal USB Flash Drive
with key ring



UD 753
Key Shape USB Flash Drive

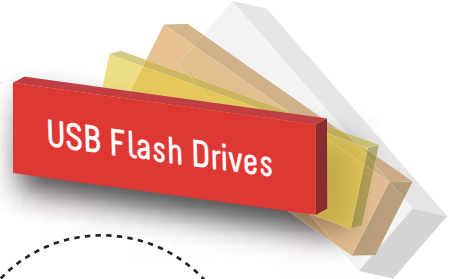

Available
 in 2, 4, 8, 16, 32 GB
 memory
 capacity

UD 759 Blue



UD 759 Red



UD 759 Black



Plastic Ball Pen with
 USB Flash Drive



UD 767

Gold Bar Model USB Flash Drive
 a must-have for jewellers
 and bullion traders



UD 756

Plastic USB Flash Drive
 comes with a string- can
 be hung on the neck



UD 768

USB Flash Drive with laser pointer



UD 701

4 GB Finger Print USB Drive,Version 2 in Standard Box.
 Your finger Print is the Password to open the flash drive



The Classic Budget
USB Flash Drives

UD 706

The Classic Budget USB Flash Drive



Green



Black



Red



Yellow



Golden Yellow



Orange



Maroon



Light Blue



Pink



White



All Black



Blue

Available in 2, 4, 8, 16, 32 GB
memory capacity





UD 752
 PU Leather/ Metal
 USB Flash Drive



UD 755
 Crystal USB Flash Drive



UD 740
 Plastic Credit Card
 Shape USB Flash Drive



UD 715
 Leather/Metal
 USB Flash Drive



*Real Leather with metal
 a timeless beauty
 Available in 2, 4, 8, 16, 32 GB
 memory capacity*



UD 758
 Leather/Metal
 USB Flash Drive



UD 745
 Leather/Metal
 USB Flash Drive



UD 705
 Leather/Metal
 USB Flash Drive



UD 766
 Leather/Metal
 USB Flash Drive



Metal USB Boxes



Plastic USB Boxes



Plastic USB Pen Box

**PLATIGNUM - U.K.
 Pens**

YOUR handwriting says a lot about you - and so does the pen you hold. That's why over a century's experience as pen pioneers has led Platignum to create this distinctive range of quality pens. From the self-filling ranges manufactured in 1919, Platignum invented the world's first replacement nib, created the retractable ball-point in 1950 and introduced the first cartridge system. Platignum, the U.K. pen pioneers have been writing the history of the pen for generations and are continuing to innovate for the future.



MP 865



MP 866



MP 867



MP 868



MP 863



MP 864



MP 870



MP 869



XDDESIGN®



Silver



Black

MP 884

XDDESIGN® Vito is a stainless steel ballpoint pen with an unique top design. The pen can be refilled. Registered design®. Blue ink cartridge, with capacity of at least 2 kilometer of ink

Designed by:



Ryan McSorley
Ireland



MP 880

XDDESIGN® Exacto is a stainless steel ballpoint pen where simplicity and finish makes the design. The pen can be refilled. Registered design®. Blue ink cartridge, with capacity of at least 2 kilometer of ink

Designed by:



Antoine
France



Black

Silver

Grey

White

MP 883

XDDESIGN® Bolt is a complete stainless steel ballpoint pen with matt finish. The pen can be refilled. Registered design®. Blue ink cartridge, with capacity of at least 2 kilometer of ink

Designed by:
 Luke Burley
 England

BALMAIN

PARIS

BALMAIN
Writing Instruments

**Ready
Stock**



MP 851 Purple
BALMAIN Ballpoint with
fashionable gift box



MP 851 White
BALMAIN Ballpoint with
fashionable gift box



MP 851 Blue
BALMAIN Ballpoint with
fashionable gift box



MP 881
BALMAIN Gift Set with
rollerball and ballpoint pens



MP 882 Black
BALMAIN Leather wrapped
ballpoint with pen pouch



MP 882 Brown
BALMAIN Leather wrapped
ballpoint with pen pouch



BALMAIN

PARIS



Ready Stock

MP 812
Set of BALMAIN Ballpoint pen & Roller pen with carbon fibre finishing



MP 825
BALMAIN pen set. aluminium. ballpoint & roller point



MP 852
Luxury BALMAIN wooden-style set of ballpoint & roller point that offers a rich image when presented in a unique and magnificent giftbox



MP 826 - BALMAIN Pen Set
Elegant and timeless pen set with ballpoint and roller ballpoint.

BALMAIN

PARIS



MP 850
High quality BALMAIN set containing
a ballpoint and roller ballpoint presented
in a matching BALMAIN gift box



MP 821
BALMAIN Ballpoint with
velvet pouch



MP 823
BALMAIN Ballpoint



MP 822 - BLACK
BALMAIN Ballpoint with
velvet pouch



MP 822 - BLUE
BALMAIN Ballpoint with
velvet pouch



ARMOUR - 98097-20
Triangular ball pen, twist type,
Lamborghini blue ink refill.



SOLURI - 98178-30
Ball pen, Lamborghini blue ink refill.



OLIVETO - 98123-80,10,20
Triangular ball pen, Lamborghini blue ink refill.



Lamborghini pen box.



Lamborghini tin box
for exclusive pens.



PISTON - 98098 -20,10,19
Ball pen, Lamborghini blue ink refill.

SANTHOME

SANTHOME
High Quality Metal
Writing Instruments

**Ready
Stock**



MP 861 R & B



PB 1012 BOX



MP 669



MP 833



PB 1003



MP 827



PB 1003



MP 828



MP 862 R & B
Black



MP 862 R & B
Brown



MP 862 R & B
Navy



SANTHOME



MP 858 SET



PB 1012



MP 876R MP 876B



MP 665B MP 665R



PB 1012



MP 831B

SANTHOME

SANTHOME
 High Quality Metal
 Writing Instruments

**Ready
 Stock**



MP 875 R & B

MP 856
 Black

MP 856
 Blue

MP 857

MP 853

MP 666

PB 1010
 PU Leather
 pen pouch

Good Quality
 Metal Writing Instruments

**Ready
 Stock**



MP 878 R & B

MP 677
 Striped Pen

MP 879

MP 855
 Black

MP 855
 Blue

MP 854
 Black



PEN WITH SWAROVSKI ELEMENTS



SP 303

PB 1003

STYLUS PENS

METAL - WOOD PEN SET



SP 301
 Specially designed for inputting in common smart phones including iPhone, & for daily writing in paper box



MP 859
 Use includes inputting in smart devices; ballpoint for daily writing; unique rich golden color.



PB 1012 BOX



MP 623R MP 623B



MP 662
 Brown



MP 662
 Black

PB 1002

SANTHOME



**Good Quality Metal
 Writing Instruments**



Blue

Silver

Black

Maroon

MP 809



PB 1004



MP 686

Special-
 Convocation Pen
 The appropriate Graduation Gift

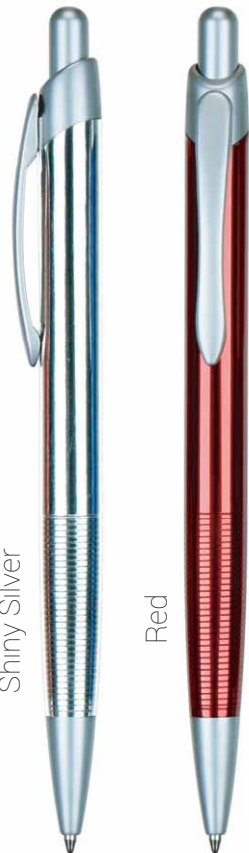

Shiny Silver

Red

MP 841



Gun Metal

Black

MP 860

**Ready
 Stock**



MP 622



MP 682
 Blue



MP 682
 Maroon



PP 259

This unique model has regional design moulded all through the pen body



PP 233



PP 222

PP 223



PP 225



PP 232



PP 245

Set of ballpen & pencil in set box packing



Quality Plastic Pens

Ready Stock



PP 253

PP 254

PP 258



PP 257

PP 256

PP 255



eco-neutral



Transparent blue body

PP 265

Retractable Ballpoint Pen made from recycled bottles PET material



Transparent white body



PP 278

Anti-bacterial Ballpoint pen. The body of the pen is made with a silver-ion compound which has an anti-bacterial effect. Made in the EU (Hungary). Antibacterial effectiveness is verified by the Industrial Microbiological Services Ltd. Registered in England, No 3264423

Good logo space on the clip

PP 227

Feather ball point pen with as base.



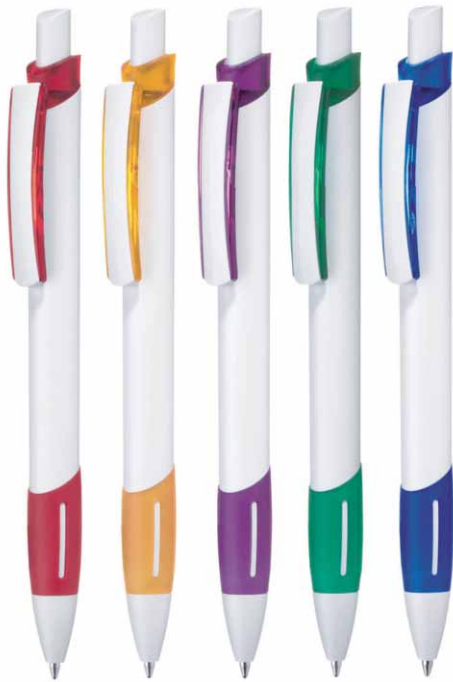

PP 242

Retractable ballpoint pen in white with transparent frosted soft-grip zone, fitting and clip shell



PP 238

Retractable ballpoint pen with nickel-plated metal clip and push button. Transparent clip attachment, silver lacquered barrel



PP 243

Retractable ballpoint pen with soft-grip zone and push-button clip. slightly curved clip. barrel and tip in solid white. pen terminal and padded soft-grip zone in one solid color



PP 243FLAG

This pen from UMA-Germany represents the national flag colours of some Middle Eastern countries.



PP 235

Retractable ballpoint pen with white barrel and colored frosted clip



PP 236

Retractable ballpoint pen



PP 240

Retractable ballpoint pen with solid-colored transparent frosted barrel and clip, and silver retractable cap



PP 241

Retractable ballpoint pen in solid color black with silver retractable cap



* Look for the **UMA** brand on the pen



SP 302

2 in 1 set- It consists of a 2in1 twist ball pen with integrated yellow highlighter, a replacement highlighter refill and a black D1 refill- in a practical case with transparent plastic slipcase included.



PP 244

Twist ballpoint pen with shiny solid colored body, heavy, matt chrome metal tip and metal clip



PP 252

The pen for FOOTBALL lovers



PP 237

Twist ballpoint pen with silver top, barrel in carbon look and heavy metal tip in matt chrome.



PP 272

Retractable Ballpoint pen with square clip for QR code printing. Shiny silver tip and push-button.



PP 271

PP 251

Retractable Ballpoint pen with extra strong large clip and a solid shiny body



PP 275

PP 277

PP 276

Retractable Ballpoint pen with slim, transparent shiny barrel with rubber grip zone and frosted curved clip

Twist Ballpoint pen with silver shiny solid body and brilliant chrome plated tip

Twist Ballpoint pen with shiny solid body, matt clip surface and brilliant chrome plated tip



Look for the
BIODEGRADABLE mark



PP 273

Retractable Ballpoint pen with curved clip. Made of bio-degradable plastic according to DIN EN 13432:2000-12. Barrel and push-button in uniform natural colours.



PP 274

Retractable Ballpoint pen with curved clip. Made of bio-degradable plastic according to DIN EN 13432:2000-12 in uniform transparent finish.



Look for the
BIODEGRADABLE
mark

PP 239

Retractable ballpoint made in biodegradable plastic according to DIN EN 13432:2000-12

* Look for the **UMA** brand on the pen



Eco Friendly Articles
 Folders, Stationeries

eco-neutral



UI 1240
 Color Pencil Set



UI 1242
 Notebook made from recycled & recyclable material

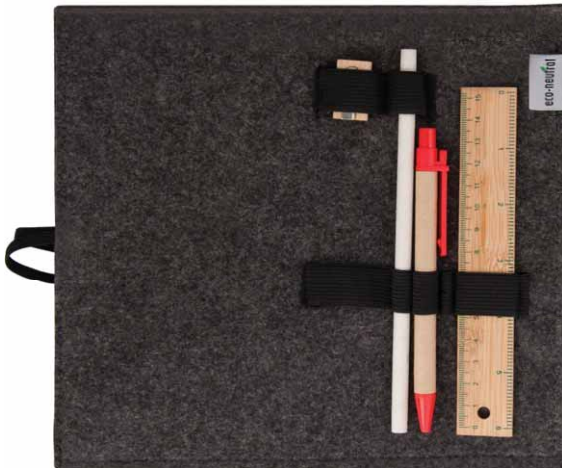

UI 1243
 Set of Pencil, Sharpener, Pen and Scale Material Felt (eco friendly)



UI 1251
 Your (eco) friendly alternate Stapler without staple pins. Made from recycled materials. Stapling depth: 7mm; Does not use staple pins so saves on supplies; Performance: 4 sheets; Reusable and non-toxic material quality. Recommended for use whenever you have only a couple of loose sheets in order to save resources and do your bit for the environment.



MT 331
 Green Line-Eco Friendly set of daily use gift



UI 1252
 Deskpiece with stick on pads and a measuring scale, all in eco-friendly recycled/recyclable material.

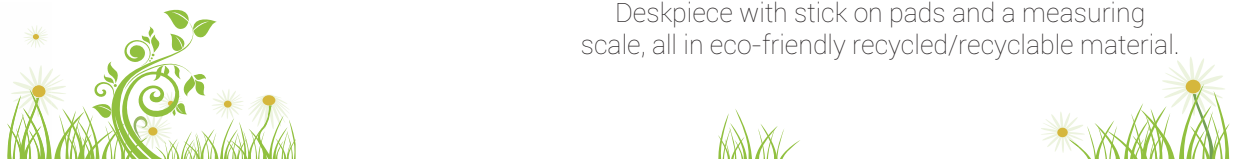



eco-neutral



3046 E



ECO-FRIENDLY LEATHER
 Leather Tanned
 the Ancient way, now forgotten.....
 Before industrialisation, leather was tanned using secretions from barks of trees (no chromium or aluminium salts/chemicals were used). This slow & eco-friendly way has been completely forgotten in today's fast-paced quick-profits world.
 This eco-friendly real leather collection has been tanned in a way that caused minimal damage (almost nil...) to the environment. Also cotton lining have been used to enhance the eco-friendliness of products to above 95%.



1015 E



1345 E

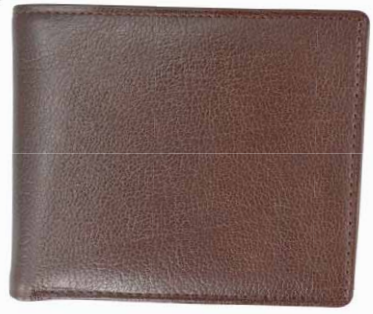

1086 E



Non-Profit
 CSR Initiative



Little Steps®

Nature friendly games and products,
 promoting your environmental and social responsibility.

Little Steps products respect nature.

Made from ECO friendly materials they all can tell your important message about protecting and nurturing our planet. Sum of many Little Steps can soon be a big leap towards a greener future.

Every Little Steps product carrying your logo will show your commitment towards positive environmental actions:

- help parents playfully educate their children about environmental problems and their solutions,
- raise general awareness about environmental issues,
- let people know that their gift has made a contribution to reforestation and local employment by Eden project.



PROBLEM & SOLUTION

Unlike standard games, a Little Steps pair is made up of two different images, one representing an environmental problem and the other its corresponding solution.



MEMORY 111914

Two-colour wooden edition
 Set of 14 different Problem&Solution pairs

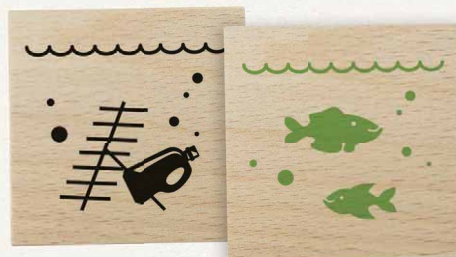

Dimensions: 50 x 50 x 6 mm / **Packaging:** 28 pieces in a cotton drawstring bag / **Extras:** Instructions leaflet / **Branding options:** front side of paper hanging tag and / or logotype on drawstring bag and / or colour scheme aligned with brand.

DOMINOES 111916

Two-colour wooden edition
 Set of 28 tiles with pictures of 7 different Problem&Solution pairs

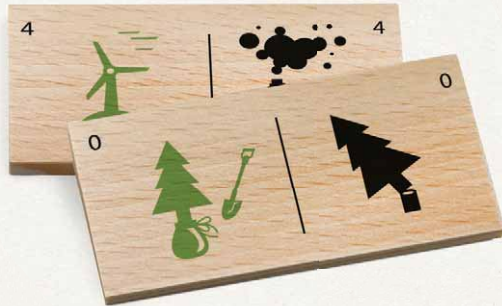

Non-Profit
 CSR Initiative

Dimensions: 66 x 33 x 6 mm / **Packaging:** 28 pieces in a cotton drawstring bag / **Extras:** Instructions leaflet / **Branding options:** front side of paper hanging tag and / or logotype on drawstring bag and / or colour scheme aligned with brand.

COASTERS 111917

Two-colour wooden edition
 Set of 6 coasters

Daily reminder of important Earth's days,
 encouraging us to be environmentally responsible
 every day.



Dimensions: 90 x 90 x 6 mm / **Packaging:** 6 pieces in a cotton drawstring bag / **Branding options:** front side of paper hanging tag and / or logotype on drawstring bag and / or colour scheme aligned with brand and / or logotype on coaster

Little Steps
 products are
 100% produced
 in EU.

HELP PLANT TREES

When trees are planted, they protect, provide, nurture & sustain all of life. Everything lives where trees live.
www.edenprojects.org

When you purchase a Little Steps product, we will make a donation in your name, to plant a new tree.

1000 Little Steps
 =
 1000 trees
 (little forest)
 +
 10 days wages
 for a local worker

CUSTOMISED

We also develop fully customized Problem&Solution stories that can be applicable to any theme, to promote your positive actions.

**BE CURIOUS,
 EXPLORE & LEARN**
www.littlesteps.si

See the whole collection.
 Find your Little Steps product, telling your story and its customization possibilities.

CONTACT: Contact us directly: Axis mundi, d.o.o., Mrs. Eva Jelnikar Mrak, E: eva@axismundi.si, T: +386 31 614 523
 Delivery time for Little steps products is 4-6 weeks.
 Little Steps is a registered trademark of Bergla design studio and Axis mundi, d.o.o. All rights are reserved.



BIO BOTTLES MADE IN THE NETHERLANDS

Tacx bio-bottles is the new water bottle for the Pro teams.
This sturdy water bottle features a powerful design and a screw-on cap.
A Tacx bio-bottle distinguishes itself thanks to a number of excellent functionalities and is easy to fill and clean.

Made in THE NETHERLANDS



- » BioDegradable
- » 100% Recyclable
- » Safe for Food use
- » Screw-on cap with a leak proof spout
- » Secure grip on triangular cap for easy-opening and closing of bottle
- » Model Available in 500cc & 750cc
- » Certified Bio-Degradable water bottles.
- » FDA Approved for contact with food.
- » OSHA Approved as Non-Hazardous.
- » Indefinite shelf life.



WB 003
Transparent
750CC

Biodegradable
100% Recyclable
Safe for food use



WB 002
Transparent
500CC

Biodegradable
100% Recyclable
Safe for food use



WB 003
Dark Blue
750CC

Biodegradable
100% Recyclable
Safe for food use



WB 002
Dark Blue
500CC

Biodegradable
100% Recyclable
Safe for food use



WB 003
Silver
750CC

Biodegradable
100% Recyclable
Safe for food use



WB 002
Silver
500CC

Biodegradable
100% Recyclable
Safe for food use

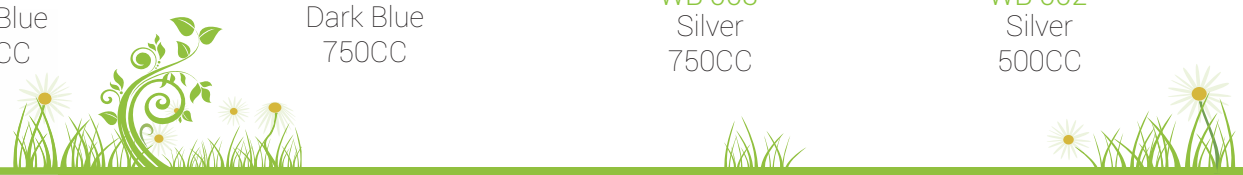

Tacx
 BIO BOTTLES MADE IN THE NETHERLANDS



WB 003
 Black
 750CC



WB 002
 Black
 500CC



WB 002
 Yellow
 500CC



WB 003
 Yellow
 750CC



WB 002
 Red
 500CC



WB 003
 Red
 750CC



WB 003
 Green
 750CC



WB 002
 Green
 500CC



WB 002
 Cream
 500CC



WB 003
 Cream
 750CC



WB 002
 Light Blue
 500CC



WB 003
 Light Blue
 750CC





XDDESIGN®

The Bopp Cool adds something extra to water and that is design. The clever cool element does what it says: Keep it cool!

Designed by:



Ryan McSorley
Ireland

XD | ECO



reddot design award
winner 2012



WB 016

XDDESIGN® Bopp Cool is an award winning design drinking bottle with a capacity of 700ml in eco-friendly BPA-free Tritan™ material. A sustainable design with an ingenious integrated cooler element to cool your drinks from inside the bottle. Registered design®.

Executed in BPA free Tritan material. Cooler part can be screwed off to be placed in the fridge. When frozen and screwed back on to bottle lid, this serves as cooler element for drinks without diluting it.





reddot design award
 winner 2012

XD | ECO

XDDESIGN®



Designed by:



Ryan McSorley
 Ireland

UI 1257

XDDESIGN® Bopp is a 600ml double wall and vacuum bottle with a matt body, contrasting lid and ergonomically designed mouth piece to deliver an optimal drinking experience. Registered design®.

Outside and inside in stainless steel with vacuum insulation. Black in between. Bottle in matt finish.



XDDESIGN®



Designed by:



Ryan McSorley
 Ireland



reddot design award
 winner 2012

UI 1258

XDDESIGN® Bopp Hot is a 600ml double wall flask with matt body, push closure and cup with handle in contrasting finish, ideal for the trendy coffee drinker. Registered design®

Outside and inside in stainless steel with vacuum insulation in between. Bottle in matt finish.

SLAZENGER Flask

Double walled sportive design lid, can be used as cup, keeps drink warm. 1 litre Capacity



XDDESIGN
Drinkware

Designed by:
Karl Malmvall
Sweden



**Ready
Stock**

XDDESIGN®

UI 1259

XDDESIGN® Wave Grip is a 700ml double wall and vacuum flask in an elegant stainless steel design and contains two matching cups with grip to deliver an optimal drinking experience. Registered design®.

Outside and inside in stainless steel with vacuum insulation in between. Push-to-pour button integrated in lid, and ABS carry handle.

Designed by:
Mike Lambourn
England



UI 1260

XDDESIGN® Auto is a 400ml Tumbler with black PP coating and an innovative push system which allows you to control it with only one hand.

Ideal for in the car.
Registered design®.

Stainless steel outside, PP inside.
Push button to enable drinking at side of the lid.



Designed by:



Antoine
France

UI 1261

XDDESIGN® Urban is a 400ml mug which is ideal to use on your desk and to enjoy your coffee or tea. Registered design®

Stainless steel outside, PP inside with leakproof closure lid.



Designed by:
Emma Sandberg
Sweden

UI 1266

XDDESIGN® Contour is a distinguished 500ml insulation flask with design shiny waist ring for your first class cup. Registered design®



High Quality Drinkware



Hans Larsen

UI 1235
 Hans Larsen brand double-walled stainless steel auto mug with a car charger; set your desired temperature 500ml capacity.



UI 1256
 This model has USB port connection



UI 1241
 Hot & Cool Set
 Stainless steel & aluminium High quality
 Hot-0.75Ltr, Cool- 1Ltr



UI 1246
 Car stainless steel mug -
 in & out steel



UI 1245
 Car stainless steel mug -
 food grade plastic interior



8 pcs (4 pcs cup & 4 pcs saucer) Espresso Set
 - Metal Plated Ceramic
 - Shiny Silver Luxury Set

*safe for food contact

XDDESIGN®



Ready Stock

UI 1265
 XDDESIGN® Early Bird is your fun start of the day that delivers fresh coffee for 2. With 350ml capacity of the coffee press, you can even get an instant refill. Comes with bird decorated spoons. Registered design®



Designed by:



Ryan McSorley
 Ireland



Ready Stock



UI 1274

XDDESIGN® Lumm brings more atmosphere in serving your beverages. With the integrated LED light this carafe is not only very functional but also a decoration piece on your serving table. Registered design®

Designed by:



Ryan McSorley
 Ireland



**Hans Larsen
 Drinkware**

Hans Larsen

HANS LARSEN mugs 16 oz

- » Food grade quality
- » Electro etched interior
- » Marine grade double wall
- » Lead free stainless steel



Hans Larsen Mug for use in car/ travel



UI 1230
 White



Check for this logo at the bottom of the mug.



UI 1230
 Silver

UI 1230
 Royal Blue

HANS LARSEN bottle
 Unique square shape aluminium bottles with carabiner



Check for this logo at the bottom of the bottles

HANS LARSEN bottle
 Unique triangular shape aluminium bottles with carabiner



WB 015
 Grey 500ml

WB 015
 Silver



WB 010
 Silver 600ml

WB 010
 Grey



WB 011
 Silver 750ml

WB 011
 Grey



Hans Larsen



Why buy **HANS LARSEN** mugs and spend a little more when cheaper unbranded versions are available?

HANS LARSEN mugs 16 oz

- » Food grade quality
- » Electro etched interior
- » Marine grade double wall lead free stainless steel
- » Strong patented handle (Check for yourself!)
- » Patented lid
- » Glossy coated in unique colours **NEED WE SAY MORE?**



Check for this logo at the bottom of the mug.



UI 1208 White



UI 1208 Navy Blue



UI 1208 Dark Green



UI 1208 Green



UI 1208 Gold



UI 1208 Royal Blue



UI 1208 Red



UI 1208 Charcoal Black



UI 1208 Pearl

XDDESIGN
 Miscellaneous Items

XDDESIGN®

Designed by:



Ryan McSorley
 Ireland

XD | ECO



UI 1269

XDDESIGN® Pip is the oil & vinegar set for those working with great precision. The 2 pipettes make it easy to add the right amount of oil or vinegar to your dish. Registered design®



Designed by:



Ryan McSorley
 Ireland



DT 616

XDDESIGN® Vlam is a table light, ideal for some extra warmth during colder days, or for some romantic dim light. Made of iron and glass, you can use it indoor as well as outdoor, it will bring light and warmth to your table. Registered design®



10 Days Delivery

Designed by:



Ryan McSorley
 Ireland



OD 707

XDDESIGN® Nido is a carbon steel barbecue for the preparation of your food on those summer days. Thanks to its square shape it has more surface area to grill your delicious food just the way you like it. Registered design®



Designed by:

Jon
 England



FA 001

XDDESIGN® Gol is the soccer game to replay all those famous cups and soccer leagues in style and with even more fun. The 3-3 line set up keep the game dynamic while playing but compact and easy to take it along on all your trips. Registered design®





reddot design award
winner 2008

XD | ECO



Black

White

Blue

Green



Designed by:



Ryan McSorley
Ireland

10 Days Delivery

UI 1270

XDDESIGN® Bopp Mini is a compact 350ml bottle with a matt body and with attached carabiner that makes it easy to clip onto your bag, belt or other gear you take with you. Registered design®



Designed by:



Antoine
France

10 Days Delivery

UI 1271

XDDESIGN® Press is your vital companion in the kitchen. The 2 changeable drills make sure you have the right size for each fruit. After squeezing your fruits, the glass carafe and its pourer can go straight to the table so you don't spill any vitamins. Registered design®

Mugs & Cups

Regular Ceramic, Stoneware Mugs



White



Red/White



Black



Red/White



UI 1211: Porcelain mugs in unique shapes



UI 1210
High Quality Stainless Steel Mugs



UI 1244
Football Mug for FOOTBALL lovers



UI 1207 : Regular Stainless Steel Mugs



by *Tonino Lamborghini*



NOCETO - 98213-12
Cabin size trolley with
ultra thin aluminium handle.
by *Tonino Lamborghini*

**Ready
Stock**



MARTONE - 98185
Garment bag in black-red combination.
Ideal for holding suits, blazers, etc.

by *Tonino Lamborghini*



CERASI - 98196-30
CD case in soft PU.
by *Tonino Lamborghini*

FITILI - 98221-10
Pad holder in black color,
by *Tonino Lamborghini*



**Real Leather
 Travel Wallets**

**Ready
 Stock**

Colors available



Black Tan



PB 1017



1316
 Elegant Travel Wallet
 Leather: Cow fine milled nappa
 Details: Black wallets have an exotic Dark Grey contrast stitching,
 Tan wallets have a Dark Tan contrast stitching

Colors available



Black Tan



PB 1017

1320
 Elegant Travel Wallet
 Leather: Cow fine milled nappa
 Details: Black wallets have an exotic Dark Grey contrast stitching,
 Tan wallets have a Dark Tan contrast stitching

Colors available



Black Tan



PB 1017



1305
 Elegant Travel Wallet
 Leather: Cow fine milled nappa
 Details: Black wallets have an exotic Dark Grey contrast stitching,
 Tan wallets have a Dark Tan contrast stitching



Black



Brown

1331YDM
 Leather: Cow PDM



3214
 PU Travel Wallet

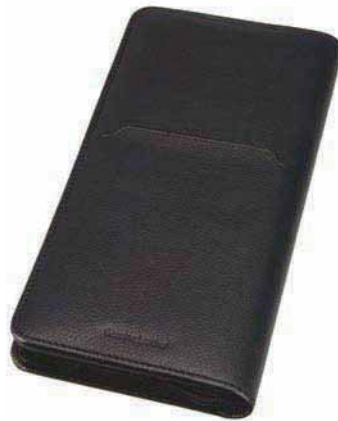

6308

SANTHOME GENUINE LEATHER
 Elegant Travel Wallet
 Leather: Cow PDM



PB 1011



#6903

Travel Luggage Tag

Details: Black travel luggage tags have an exotic Dark Grey contrast stitch, Tan travel luggage tags have a Dark Tan contrast stitching, Maroon travel luggage tags have melting Cream color stitching
 Leather: Cow fine milled nappa



Travel Accessories

SANTHOME
 CHARGE YOUR WORLD

Universal Travel Adaptor that has a smooth rubber touch and seamlessly connects and powers up your device in over 150 countries. Devices that can be handled include iPods, mobile phones, laptops, etc. Two built-in auto-switching USB chargers.

Options of capacity

- TA 114 - 1000 mA USB power
- TA 115 - 2100 mA USB power



TA 104

Protective casing



Universal Travel Adapter - for more than 150 Countries

Laptop cooling pad

- » Provided with a fan and USB.
- » Easy to use and portable.
- » High power cooling fan
- » Low noise level
- » USB powered
- » Fits 7 to 17 inch notebook
- » Light weighted 220gms only
- » Good logo printing area



UD 735

The USB cable connects to the laptop and drives the cooling fan to keep the laptop cool

Presenting a unique all in one travel adapter and charger !!!

This unique one piece design offers extraordinary travel convenience and the new "TWIST AND RELEASE" mechanism allows user to select 4 different socket styles effortlessly

- » ADAPT – connect and power up your travel electronics
- » CHARGE – built in auto switching usb charger to charge mobiles,psp,ipod etc
- » EXPAND – connect directly to your laptop,digital cameras etc
- » ANYWHERE – BUSINESS TRAVEL MADE EASY , works in over 150 countries !!!
- » CONVENIENCE – a stress free daily office routine !!!

Portable Travel Adapter & Charger



MT 333

Ready Stock

- » Charger module & adapter can function independent of one another.
- » Range of devices include MP3 players, digital cameras, mobile phones,GPSs, PDAs, travel speakers etc.
- » Parallel charging of 2 devices.

Capacity: 1000 mA USB power

Travel Adapter with 2 port USB Charger

Ready Stock



TA 103



SANTHOME
 CHARGE YOUR WORLD

White & Black Colour Options

105

Travel Accessories



TA 117

TSA Lock & Real Leather Luggage Tag Set (6903)



TA 118

TSA Lock & Detachable 4 GB USB Flash Drive - 3 in 1 (UD 703)



TA 101

TSA Lock with a Cardkey -

The TSA can use the universal 'master' key. The owner uses the card as a key.



TA 119

TSA Lock & Executive Metal Card Holder (CH 143)



TA 108

High Precision Travel Weight Scale. Super convenient and lightweight; electronically weighs luggage and displays in an LCD panel.

Santhome Gift Set

SANTHOME

Ready Stock



Set 36

Elegant PU Leather gift set - travel wallet & pen



Designed by:
 Tony Poon
 England



XD | ECO



TB 1806

All your documents packed in this business trolley. Papers and laptop can be neatly placed in one of the compartments, some of which can be locked. With duo-tube trolley system for stability on your way. Registered design®

Ready Stock



Designed by:



Ryan McSorley
 Ireland

TA 120

SWISS PEAK zippered Travel Wallet with metal Swiss Peak logo on the front. For a comfortable and practical journey, all pockets are on the inside and an integrated cord is available to hang the wallet around your neck. Registered design®

Wellness
Health, Outdoors



WN 100
Yoga Mat Set



OD 702
Beach Mat Set
foldable adjustable
backrest inclination



PP 278

Anti-bacterial Ballpoint pen.
The body of the pen is made with a silver-ion compound which has an anti-bacterial effect.
Made in the EU (Hungary). Antibacterial effectiveness is verified by the Industrial Microbiological Services Ltd. Registered in England, No 3264423



reddot design award
winner 2011



10 Days Delivery



WN 107

Keep in control of your health with this blood pressure and pulse rate meter and keep track of your history. To make it even more convenient you can easily share your data with e.g. your personal doctor. (For iPod touch, iPhone 3 & 4, or iPad only.)

Office Accessories
from BALMAIN

Integrity • Efficiency • Reliability
SELECT
Since 1989

BALMAIN
PARIS



FO 3288
BALMAIN Portfolio with zipper closure, pen loop and several pockets to store your documents.
Size: 27 x 33.5 x 3.5 cm
Accessories not included.

**Ready
Stock**

FO3286
Sophisticated designed Balmain portfolio with zipper closure, pen loop and numerous pockets to store your documents.
Accessories not included.
Size: 27 x 34 x 2.5 cm



FO3287
Stylish designed Balmain portfolio with zipper closure, pen loop, ringbinder and several pockets to store your documents.
Accessories not included
Size: 27 x 34 x 3.5 cm

Real Leather/
 Lamborghini Folders



by *Tonino Lamborghini*



3041

A4 Real leather folder made from Buff glazed leather, with a classy interior. Available in Tan & Black options



FITILI - 98221-10

Pad holder in black color, by Tonino Lamborghini



24596 Tan
 Leather : Buff grainy

PB 1023



6605 Navy
 Leather : Cow fine touch

PB 1023



6606 Black
 Leather : Cow fine touch

PB 1023



6605 Black
 Leather : Cow fine touch

PB 1023



PU Leather Folder (Portfolio)



Ready Stock



FO 3303
French designed A4 Folder with calculator. Uniquely shaped magnetic opener. Textured PU Leather.

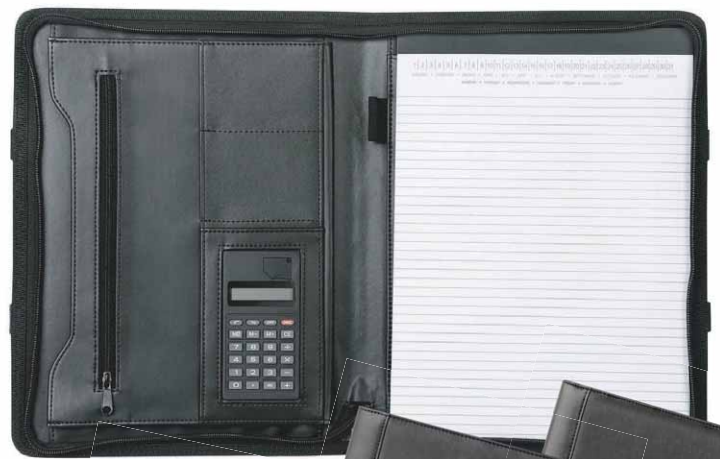

FO 3308
A4 Zippered Folder with a carrying handle and calculator.

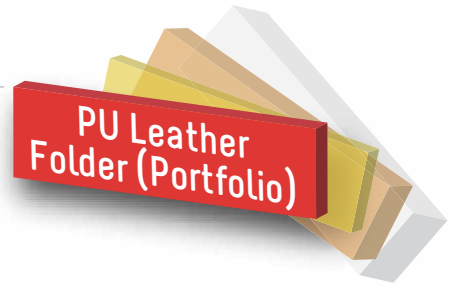

FO 3311

A4 Zip Folder in Koskin Black Material, with 2 Ring Binder and 25 page lined pad, without accessories. Made with elegant black and white striped high quality lining.



FO 3312

A5 Zip Folder in Koskin Black Material with 25 page lined pad, without accessories. Made with elegant black and white striped high quality lining.



FO 3314

A4 Zip Folder in Koskin Black Material with 25 page lined pad and Solar Calculator, without accessories. Made with elegant blue and navy striped high quality lining. The external blue stitching adds to the elegance.



FO 3302

A4 Folder with zipper opener, mobile case, calculator. A unique mechanism to access mobile phone and calculator without opening the folder. Elegant contrast white stitching.



**PU Leather Folders
 (Portfolios)**



Grey Stitch Blue Stitch Red Stitch

FO 3322

Grey A4 Folder with Calculator, Magnetic Closure; Available in choice of 3 colors stitching combination.



FO 3321

Grey A4 Folder with combination colours, with Calculator, all around zipper closing.

Grey Stitch

Blue Stitch

Red Stitch



FO 3306

A basic A4 Zippered Folder with card pocket and calculator



FO 3201

A4 folder with Calculator-Black



FO 3292

Available in Black colour



FO 3291

Available in Burgundy, Black option

PU Leather iPad Folders (Portfolios)

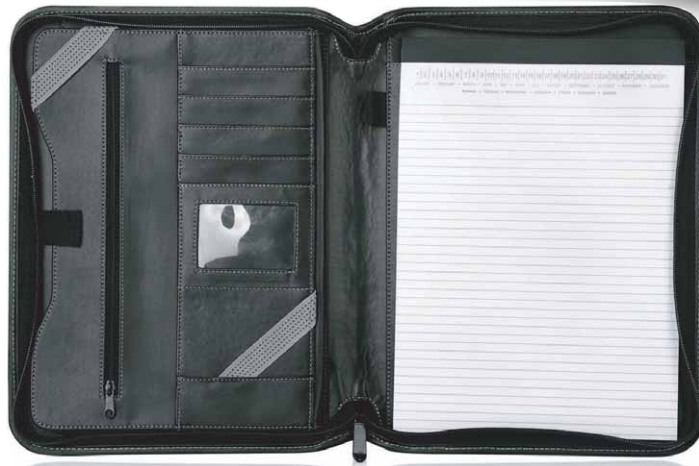

FO 3309

A4 Zippered Folder with iPad carrying straps; comes in an interesting combination of materials for a classy look. Four Colour Combinations

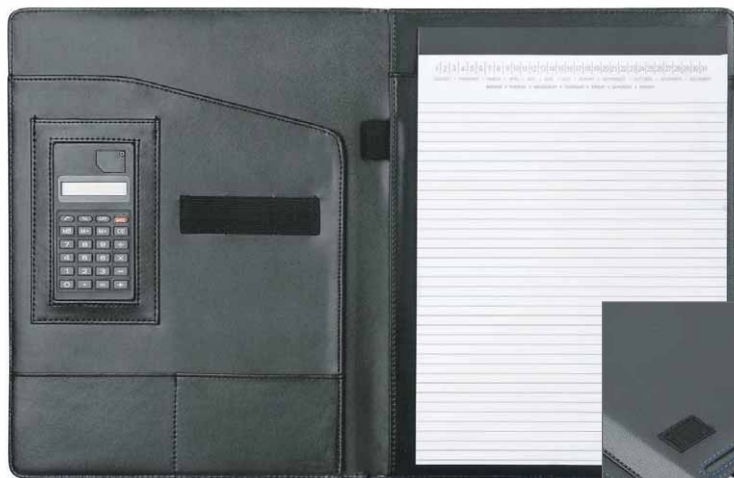

Ready Stock

FO 3307

A4 Folder with calculator and an external protective pocket for iPad.



Black/blue & black/grey colour combination options



FO 3313

A4 Zip Folder in Koskin Black Material with 25-page lined pad and iPad case to fit iPad 2, 3 and 4. Pen not included. Made with elegant black and white striped high quality lining.



**PU Leather Folders
(Portfolios)**

**Ready
Stock**



FO 3284

Black A4 folder available in
Black, Blue, Grey, Red combination stripes



FO 3202 - A4 Basic Folder
Available in 4 colours
Blue, Tan, Maroon, Grey



FO 3285

Black A4 folder available in 2 combination colours - Black, Grey

**PU Leather Folders
 (Portfolios)**



FO 3261
 Made from high-end material;
 modern design. Elastic closure;
 suitable for A4 pad



FO 3262
 Made from high-end material;
 modern design. Elastic closure;
 suitable for A4 pad



FO 3239
 A4 folder with all-around Zipper closing,
 material Koskin & EVA material -
 unique combination.



FO 3206
 A4 folder Black / Red
 combination with loop closure



FO 3206
 Black A4 folder
 with loop closure

**PU Leather
Folders & Organisers**

FO 3264 - A5 Italian model folder with contemporary black-red-beige combination.



FO 3263 - A4 Italian model folder with contemporary black-red-beige combination.



FO 3254 - 8.5 inch Italian model organiser with contemporary black-red-beige combination



FO 3253- 7" Italian model organiser with contemporary black-red-beige combination

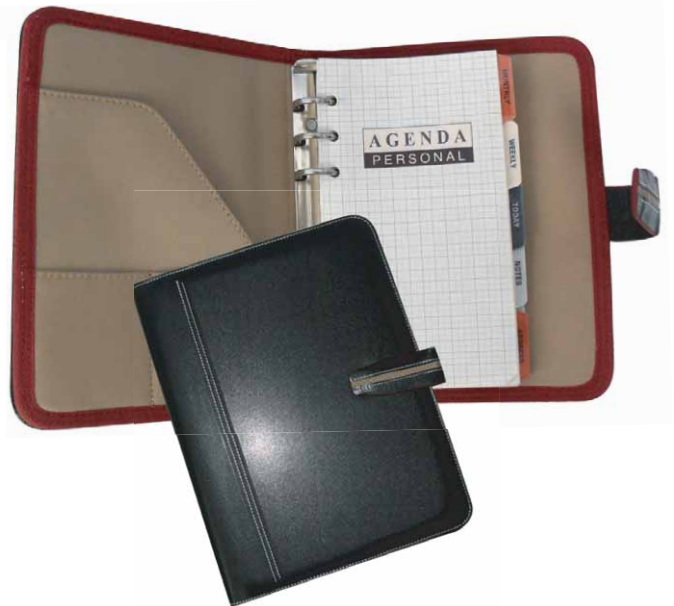

FO 3315 - Elegant 8.5 inch PU organizer with a unique magnetic closure.
(Pen not included)

PU Leather Organisers

FO 3272 - 7" Luxury PU organiser
 (Pen not included)

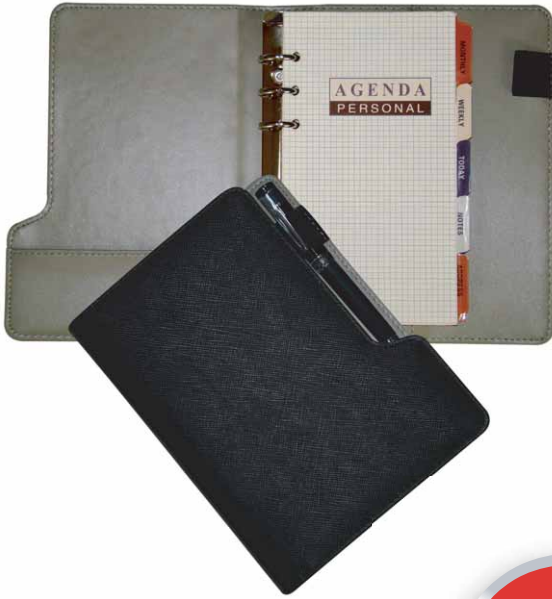

FO 3273 - 8.5" Luxury PU organiser
 (Pen not included)

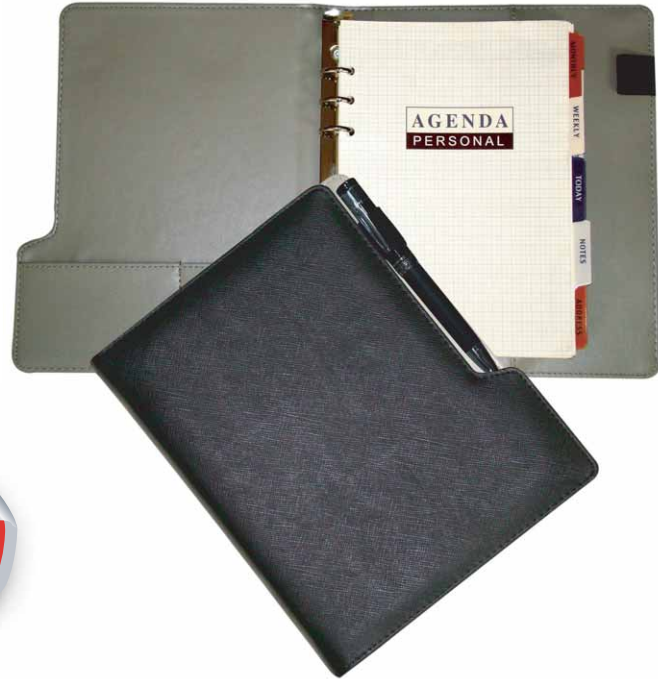

Ready Stock

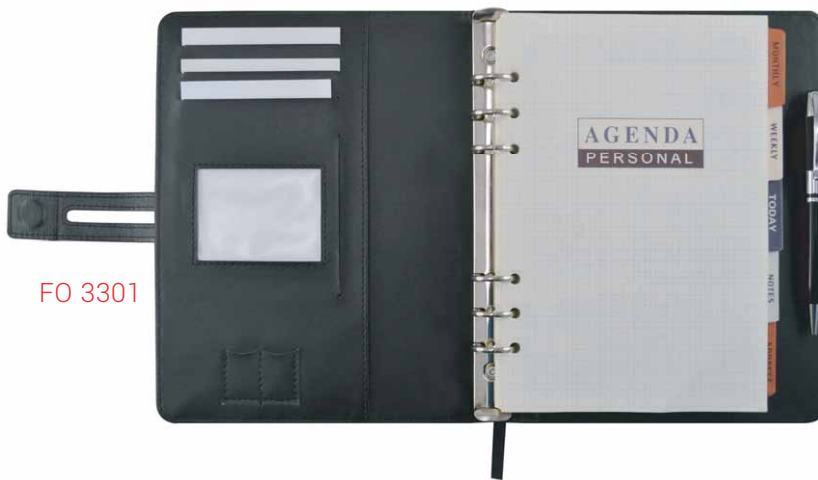

FO 3301



FO 3301
 Sophisticated blue/brown combination.
 8.5" Organizer with modern
 designed pen MP 855 (blue)



FO 3301
 Elegant black/black
 combination.
 8.5" Organizer with modern
 designed pen MP 855 (black)



FO 3301
 Elegant brown/brown
 combination.
 8.5" Organizer with modern
 designed pen MP 662 (brown)

PU Leather Organisers

FO 3237 - 8.5" Organiser



FO 3236 - 7" Organiser



FO 3232 - 5" Organiser



Ready Stock

FO 3235 - 5" Mini Organiser



FO 3233 - 7" Organiser

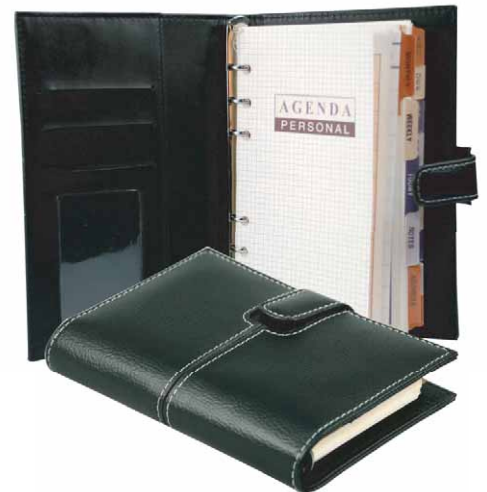

FO 3234 - 8.5" Organiser

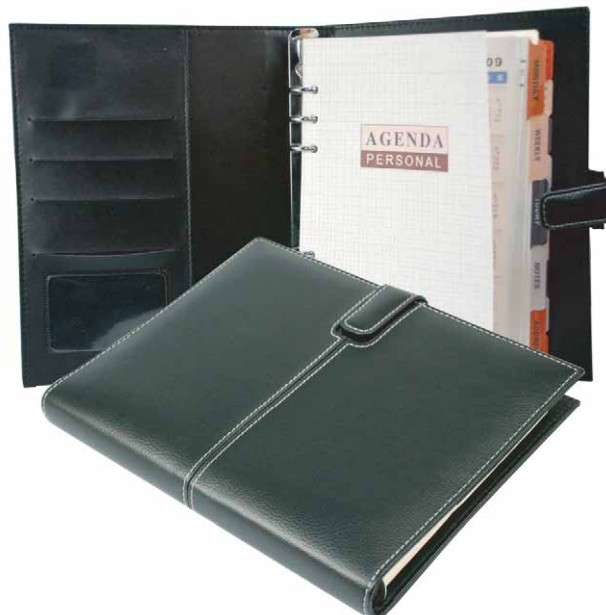

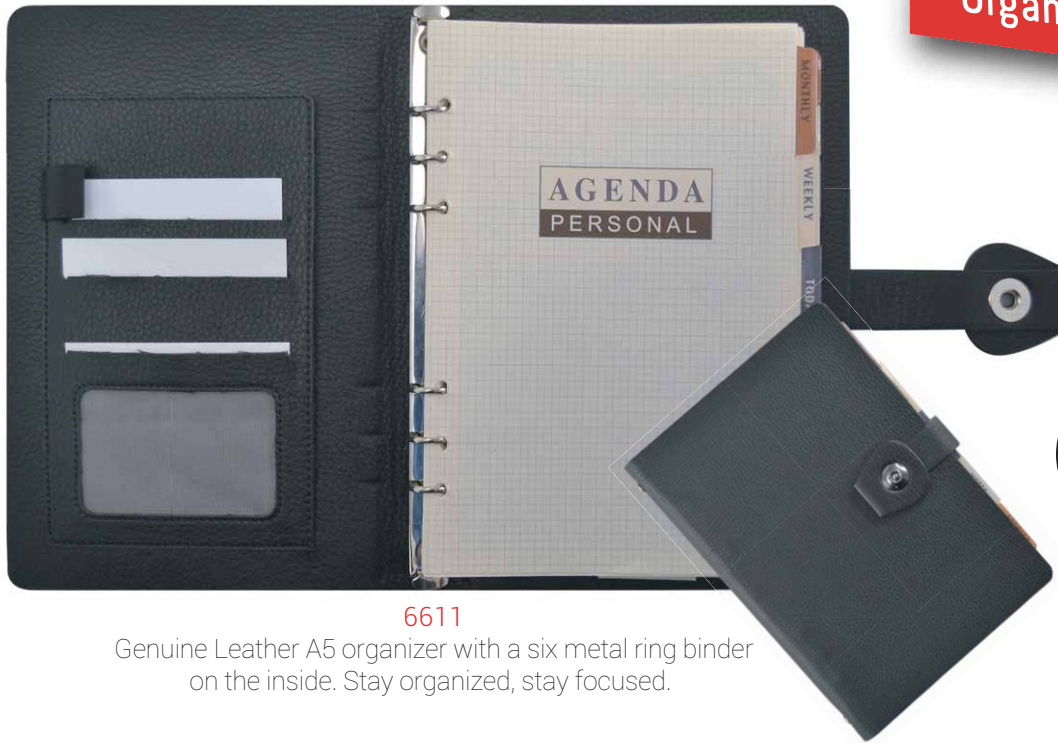

6611

Genuine Leather A5 organizer with a six metal ring binder on the inside. Stay organized, stay focused.



FO 3251 8.5" Organiser



FO 3252- 8.5" Organiser

**Eco Friendly
 Folders & Organisers**

eco-neutral



FO 3231
 File Folder A4 size, 90% Recyclable



FO 3281
 A4 Eco-friendly recycled/recyclable folder with pen



FO 3267
 A5 Eco-friendly recycled/recyclable folder with naturally fallen wood pen



A4 folder with memo pad and ball pen.
 Made using the super eco-friendly cotton-linen fabric material

FO 3282
 Organizer with memo pad, calculator and ball pen.
 Made using the super eco-friendly cotton-linen fabric material



FO 3283





eco-neutral



Light Grey Exterior



Dark Grey Exterior

FO 3289

A4 folder in an attractive light grey-dark grey and green combination with eco-friendly kraft paper pad.
 Material - felt (eco-friendly)

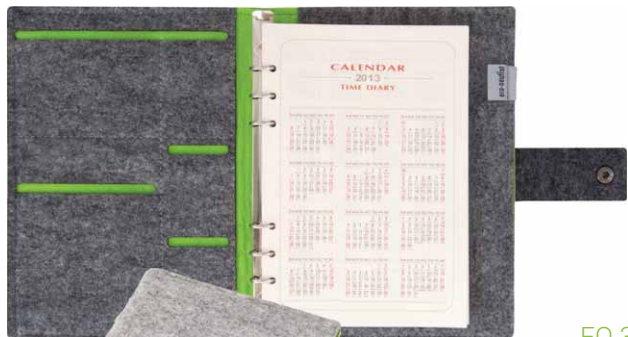

Light Grey Exterior



Dark Grey Exterior

FO 3290

8.5 inch organizer in a light grey - dark grey and green combination. Material - felt (eco-friendly)



Light Grey Exterior



Dark Grey Exterior

CH 139

Pocket Cards Holder in attractive color combinations with eco-friendly felt jacket



**SN 102
 Briefcase**



- » Material 2tone polyester + 1680d
- » Suitable for notebooks upto 36x27.4x4.4 cms
- » Magnetic front pocket for mobile, mp4
- » Detachable pouch for accessories, DVD holder
- » H. Q. bottom



**Ready
 Stock**



**SN 201
 Briefcase + Backpack**

- » Executive Briefcase + backpack for easy carry
- » Material - nylon - jaquard
- » Multiple compartments for accessories, files.
- » High quality metal fittings

**Ready
 Stock**



Ready Stock

- » Material High Quality Nylon
- » Two main compartments for more storage
- » Suitable for note book up to 15.4"
- » Seperate provision for note book & tablet
- » Elegant - magnetic flap in front



SANTHOME

Ready Stock



- » Material high density polyester
- » Suitable for 13.1" mini note books & tablets
- » Double flaps & extrathick padding for extra protection
- » Detachable mobile pouch.



Laptop Bags

SN 401
 Messenger Briefcase

Ready Stock

- » Heavy padding inside
- » Metallic finish sidebuckles
- » Three shoulder belts to match your trend
- » Additional separate compartment for tablet



Black Beige

SN 402
 Messenger Briefcase

Ready Stock

- » Material - polyester twill + PU
- » High quality corduroy material inside
- » Trendy style



SANTHOME



- » Azo free low cadmium, pvc free microfibre material.
- » Blind stitching, light weight
- » High quality aluminium fittings
- » Pockets for mobile, pen & cards



Grey Brown Black

SANTHOME



- » Azo free low cadmium, pvc free microfibre material.
- » Blind stitching, light weight
- » High quality aluminium fittings
- » Pockets for mobile, pen & cards
- » Two compartments - more space

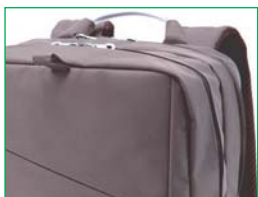

Grey Brown Black



Laptop Bags

SN 003
Slip-in Sleeve

- » Made from NBR+ polyester
- » Shake resistance
- » Hand washable, drip dry
- » Sleeve with zipper and additional front pocket for pen & documents.
- » Foldable handle inside.

Ready Stock



SN 004
Slip-in Sleeve

- » Made from NBR+ polyester
- » Shake resistance
- » Hand washable, drip dry
- » Sleeve with zipper and additional front pocket for pen & documents.
- » Foldable handle inside.

Ready Stock

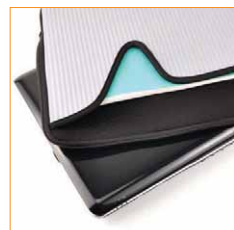

SANTHOMÉ



BALMAIN
PARIS

SN 3184
Briefcase

**Ready
Stock**



BALMAIN Briefcase
Luxury briefcase bag with 3 pen loops
and business card / credit card holder. 39 x 7 x 31cm

SANTHOMÉ

Laptop Bag
LPT 006

**Ready
Stock**



LPT 006 Laptop Bag cum Office Bag

**SN 302
Briefcase**

**Ready
Stock**

- » Exclusive Quality Briefcase with high quality metal zippers
- » Designer Handle
- » Suitable for Laptop up to 15.4"
- » Branding Space
- » Leather Look



Black / Silver



Brown / Gold



**SN 1401
Tablet / Shoulder Bag**

**Ready
Stock**

- » High Class Tablet - Bag
- » Stylish Design with Golden Metal Zippers & Fittings
- » Suitable for Tablets up to 10"
- » Exclusive Shoulder belt



SANTHOME



- » Premium Quality Durable Material
- » Neatly Crafted with High Quality Metal Zipper & Accessories
- » Full Lining Inside with Padding
- » High Quality Trolley & Wheels
- » 20" inch - Ideal as cabin hand baggage
- » Exclusive Handle + shoulder belt



**SB 2001
Sports Bag**

**Ready
Stock**



- » High quality nylon material (ideal for sports bags)
- » Can be carried as backpack or as shoulder bag
- » Full waterproof lining inside, high quality tarpouline base
- » Shoe pouch & net pockets for keeping socks & accessories
- » Ideal sports bag with stylish design & high quality finishing



SN 403
Messenger Laptop Bag



- » Material - High quality PU
- » Full lining inside
- » Laptop compartment Suitable for notebook up to 14 inches
- » Trendy design

Ready Stock



SANTHOME

SB 2102
PU Sports Bag



Ready Stock

- » Material - High quality PU
- » Full lining inside
- » Size: 19 inches
- » Stylish sports bag

**SLAZENGER
GYM Bag**



**Ready
Stock**

Stylish Slazenger utility gym bag, equipped with a large main compartment, front zippered pocket and a mesh water bottle container on the front. Size: 45 x 28 x 27 cm



SLZ GYM Bag



**SLAZENGER
Sports Bag**



**Ready
Stock**

Slazenger sports bag made perfect for athletes and sportsmen who need to protect their gear from a muddy field, rainy day or wet locker room floor. Multi-utility bag with extra pockets to handle additional sports gear. Size: 50 x 29 x 29 cm



SLZ Sports Bag



Dual use Slazenger shoulder bag.
Sporty rucksack with padded laptop
compartment and various functional pockets.



SLZ Laptop Bag



Slazenger Sportspersons' rucksack in blue-black
combination. Main zippered compartment with media
pocket and ear bud socket. Front zippered compartment
with an organizational panel. Size: 47.5 x 32.5 x 15 cm



SLZ Rucksack



Laptop Bags

**SN 501
 Shoulder Bag**



- » Material 1680d
- » Suitable for notebooks upto 36 x 27.4 x 4.4 cms
- » Sleek design
- » Trendy single shoulder strap with detachable mobile pouch
- » Multiple pocket options



**SN 502
 Shoulder Bag**

SANTHOME



- » Material two tone nylon
- » Suitable for notebooks upto 36 x 27.4 x 4.4 cms
- » Sleek design
- » Trendy single shoulder strap with mobile pouch
- » Multiple pocket options



Laptop Bags



- » Material heavy two tone grey polyester
- » Suitable for notebooks upto 36 x 27.4 x 4.4 cms
- » PU bottom
- » Magnetic flap
- » Multiple file compartments inside



SANTHOMÉ



- » Suitable for notebooks upto 36 x 27.4 x 4.4 cms
- » Extra soft comfortable shoulder belts
- » Trendy combination lining
- » Expandable compartment for more space

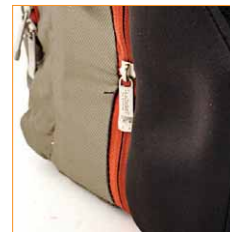

Laptop Bags

**SN 603
 Backpack**

- » Material nylon with lamination
- » Suitable for notebooks upto 36 x 27.4 x 4.4 cms
- » Specially designed shoulder pad for extra comfort

**Ready
 Stock**



Laptop Bags

**SN 606
 Backpack**

- » Material 1680d
- » Suitable for notebooks upto 36 x 27.4 x 4.4 cms
- » Side way opening for easy operation
- » Stylish front panel

**Ready
 Stock**



- » Classy Sports Backpack
- » High Quality Durable Material
- » Separate Compartment for sports gear, ball, shoes etc.
- » Padded compartment inside for laptop

**SN 705
Sports Backpack**



**Ready
Stock**



SANTHOME

- » Material 1680d
- » Suitable for notebooks upto 36x 27.4 x 4.4 cms
- » More space for other stuff inside
- » Backpack +trolley two options
- » Heavy padding for back

**SN 801
Backpack Trolley**

**Ready
Stock**





SANTHOME

- » Material high quality nylon.
- » 4 Rotating Wheels for easy handling.
- » Multiple Utility Pockets.
- » Provision to keep clothes for travelling
- » Overnighter + Executive Trolley.
- » Suitable for notebook up to 15.6 inches



Detachable Laptop Cover



-
-
-
-
-



**SN 951
 Executive Trolley**

**Ready
 Stock**



- » Material twill polyester+PU
- » Suitable for notebooks upto 36 x 27.4 x 4.4 cms
- » Multiple compartments for files & documents
- » Elegant corporate look
- » Heavy trolley cart



SANTHOME

**SN 901
 Overnighter Trolley**

**Ready
 Stock**



- » Material 1680d + PU
- » Suitable for notebooks upto 36 x 27.4 x 4.4 cms
- » Two compartment compact design
- » Provision to keep clothes for travelling
- » Spacious front pocket with organizer
- » Heavy trolley cart.



Laptop Bags

**SN 607
Backpack**

- » Material - High Quality Nylon
- » Two separate compartments for laptop & tablet
- » Suitable for 15.4" laptop & 10" tab.
- » Trendy style



**LPT 004
Laptop Bag**

- » Material - micro fibre
- » Laptop compartment for 15.4"
- » Expandable for more stuff

**Ready
Stock**



Ready Stock

**TB 1801
 20" Foldable
 Cabin Trolley**

- » 20" (cabin size) travel luggage trolley
- » High quality two tone nylon material
- » Heavy duty wheels & very high quality trolley fitting
- » Foldable - saves space in storage
- » Soft front with side zipper pockets
- » Branding space on front strap (ideal gift)



Folded



Open



High quality trolley



Expandable compartment



Branding space



**BP 1201
Backpacks**

**Ready
Stock**



Black



Navy blue

**BP 1001
High Quality Backpacks**

SANTHOME

**Ready
Stock**



Beige / Grey / Black



Beige / Red / Black



Beige / Royal Blue / Black

BP 1002
High Quality Backpacks

**Ready
Stock**



Black / Maroon / Grey



Black / Aqua / Grey



- » Large main compartment
- » Front zipper pocket with organizer inside
- » Open pocket with buckle
- » One large padded separate compartment for laptop
- » Material - 600d polyester

BP 2001
Laptop Backpack

**Ready
Stock**



W 30 x H 46 x D 29 cms



Black / Charcoal / Royal Blue



3139 - Foldable Round Bag



Black/Red



Red / Black



Beige / Navy Blue



Navy Blue /Beige



Petrol Grey / Navy Blue



Black

Ready Stock

TB 1501 Trolley Bag



TB 1501

Ready Stock



Black & Grey



Red & Grey



Nay blue & Grey

Travel Bags
Model # 3134



Black/Red



Navy Blue

**Ready
Stock**



Beige / Navy Blue



Petrol Grey / Navy Blue



Black



Petrol Grey / Black



Red / Black



Royal Blue / Black

Foldable
Prayer Mat / Bag

**Ready
Stock**

- » High quality prayer mat from TURKEY
- » Enough branding space



PMT 001
Navy Blue



PMT 001
Grey

CUSTOMISED

Prayer Mat



Foldable Bag

Sleeper Bag



Foldable Haj - Umrah Set



Travel & Sports Bag



SB 001



SB 011



SB 004



SB 012



SB 008



SB 009



SB 010

Shoulder /
Body Hug Bags



SH 001



SH 002



SH 003



SH 004



SH 006



SH 007



SH 008



BP 002



BP 013



BP 012



BP 014



BP 008



BP 010



PCH 001



PCH 002



BP 011
Kindergarten School bags



Executive / Documents Bag



EX 001
Material: 600D



EX 004
Material: 1680D + PU

CUSTOMISED



EX 005
Material: 600D



EX 002
Material: Microfibre

File Cases & Folders

CUSTOMISED



FO 001

FC 002



FC 001

CD Cases

CUSTOMISED



CD 002



CD 001



Messenger Bags



MB 003



MB 002



MB 001



MB 004



MB 006

Laptop Back Packs



LP 501



LP 503

More Ideas...
for your BRAND



Travel kit



Tool kit with reflector

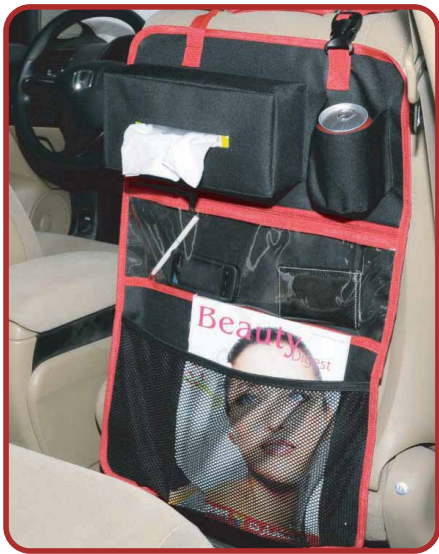

Car kit



Sports kit bag



WC 001

Spare wheel cover

WC 002

Available in Indian & Korean rexines



Bean bag



CUSTOMISED

Cooler Bags



CB 502

CB 001



CB 003



CB 004



CB 701
 Foldable string bag
 + Cooler bag

Duffle Bag

Wallet

Waist Pouches



DF 002



CP 501



WP 002

WP 001



WP 003

String Bag

First Aid Kit



ST 003



Pizza Delivery Box

Cosmetic Pouch



CP 001



CP 002

Eco friendly / cost effective / ideal for exhibitions

Jute Bags

eco-neutral



JT 501

Foldable shopping bag
Size: H 28 x W 33 gusset 22 cms
» Easy to carry

Ready
Stock

JC 002

JUCO (JUto + COtton)
shopping bag
Size: 37 x 24 x 8 cm



JT 601

Jute trendy shopping bag with Cotton patches
Size: 36 x 34 cm



eco-neutral



White

JT 101
38 x 30 x 12 cms



Natural



White

JT 201
33 x 43 x 15 cms



Natural



JT 003
38 x 30 x 12cms



JT 401
30 x 20 cms
Gift pouch



Eco friendly / cost effective / ideal for exhibitions

Jute Bags

eco-neutral

Ready Stock

JT 301
18 x 18 x 18 cms



White

Natural

Cotton Pouch

Ready Stock

CT 301



eco-neutral

Cotton Tablet Case

Ready Stock



- » Suitable for tablet upto 10"
- » Cotton case with jute loop



CT 601



eco-neutral



White

100% Cotton Biodegradable

CT 001
H42 x W38 cms



Natural



CT 001
H42 x W 38 cms

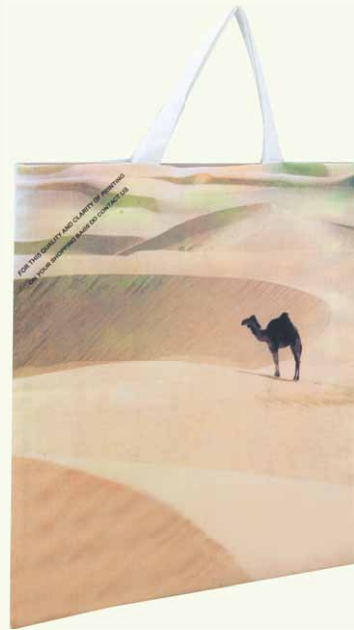

Can be customised with full color graphic printing as above



White



CT 101
38 x 30 x 12 cms



Natural





Eco friendly / cost effective / ideal for exhibitions

eco-neutral

- » 100% Cotton Biodegradable
- » Separate currency pocket
- » Easy to carry

Ready Stock



CT 501
Cotton wallet with Foldable shopping bag

Ready Stock



Natural



White

CT 401
Cotton Draw String Bags

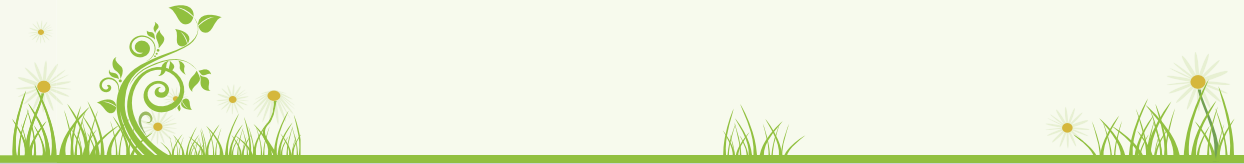



Red



Black



Royal Blue



White



Navy Blue



Cream



White / Green



White/Navy



White/Orange



White/Black



White/Red



White



White/R.Blue



White/Maroon



White/Grey



Black



Eco friendly / cost effective / ideal for exhibitions



Ready Stock

Recycled PET Bags

- » 85% Recycled PET non woven from post consumer wastes.
- » Recycled & Recyclable material



Outer side



Inner side

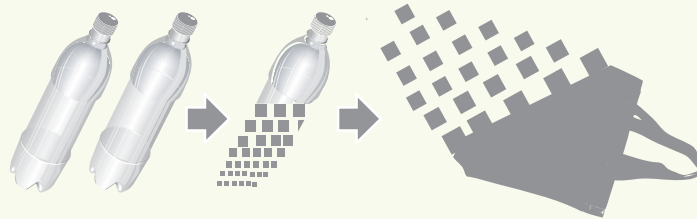

PET Waste Recycled to make this Bags



White/green



White



White/Navy Blue

RPET 001
 38 x 30 x 12 cms.



Caution - Promoclips do not cut fingers & papers. Are you sure about other brands? Buy only the original.

Promoclip original



Finish your precious correspondence with an original Promoclip carrying your own logo. More and more companies decide to distinct themselves this way. A Promoclip matches your corporate identity perfectly and offers space to print your logo and to promote your website or slogan. Promoclips are easily put on paper by giving it a gentle twist. Each clip has been carefully smoothed to avoid possible damage to the paper. Also the patented bends on the back of the clip enable you to put on a clip without using any force.



ML Clip original



ML Clips are considerably larger than Promoclips and offer enough space to print a product photo or state your complete company details. Not only its size, but also its strenght is unique: an ML Clip holds 2 to 35 sheets of paper together!

This clip is really one of a kind. Available with digitally printed labels or laser engraving.

XL Clip original



The XL Clip safely holds together bank notes, credit cards and receipts. Carrying a solid laser engraving, the XL Clip offers sufficient space to show your logo and even a message.

Give your client an XL Clip as a 'thank you' and he will think back of you frequently. Obtainable in a semi-transparent give away box, offering space to leave your business card as well.

Already available as of 50 pieces.

PROMOCLIP[®]
 ORIGINAL *Made in Holland*

Minimum
 Promoclip print 2.500 clips
 Promoclip sticker 1.000 clips
 Promoclip laser 1.000 clips

Quality
 Stainless steel
 Not sharp

Power
 2 - 15 sheets

ML CLIP[®]
 ORIGINAL *Made in Holland*

Minimum
 ML clip sticker 500 clips
 ML clip laser 500 clips

Quality
 Stainless steel
 Not sharp

Power
 2 - 35 sheets

XL CLIP[®]
 ORIGINAL *Made in Holland*

Minimum
 XL clip laser 50 clips

Quality
 Stainless steel
 Brushed
 Not sharp

Keyrings



Real Leather



Keyrings



KC 2037



KC 2033



KC 2031



KC 2034



KC 2045



KC 2032



2004
Real Leather Key Fob



KC 2021



KC 2022



KC 2020



KC 2026



KC 2025



KC 2024

Ready Stock

Smart keyholders with a sim card pocket; practical, useful, with enough logo space

Stress Relievers



SB 1003



SB 1004



SB 1001



- Stress Relievers
 (Round and Dice (Square) shapes)



SB 1002

Keyrings



MT 338 - Torch Keylight
 WEEE-compliant



KC 2023



MT 339
 Bright LED Keyring
 WEEE-compliant



KC 1317
 (Keyring with clock)



SBKC 1005
 Football stress reliever keyring
 for FOOTBALL lovers

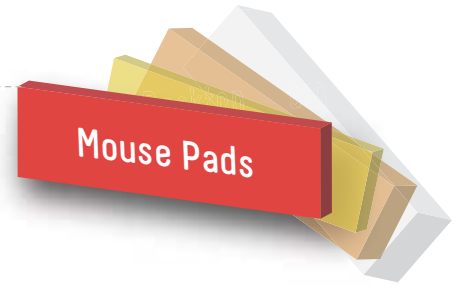

Royal Blue

Red

White

Navy Blue

Black

DT 569

Mouse pads with memory foam wrist support



Black

Navy Blue

White

Royal Blue

Red

DT 519

Mouse pads with memory foam wrist support



DT 521

PU Ultra Thin Mouse Pad



GS 902



GS 901 (Item without pen. Pen slot provided to put any model of pen separately available.)



GS 1104

Lanyards

Ready Stock



LY 884

(Lanyard with detachable clip)



LY 885



LY 881



LY 882

Badge Reels



755

756



LY 883



LY 886

ID Card Holders



754



752



751



753

Best quality lanyards are available with us in all standard colors and sizes (10 mm, 15mm & 20mm).

- » Fabric - nylon polyester.
- » Clips - alligator and swivel clips
- » We can customize lanyards according to customer requirements.

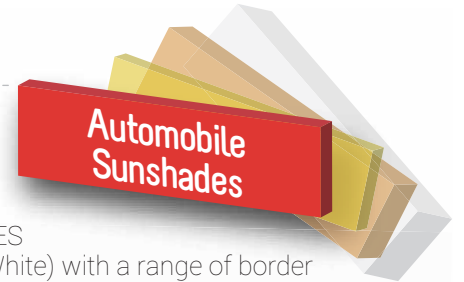

UI 1213

DUPONT TYVEK SUNSHADES

Stocks available in original Dupont Tyvek Sunshades (White) with a range of border colours to match logo & print matter



UI 1212

Silver / Black Polyester Sunshades



XDDESIGN
Automobile Accessories

XDDESIGN®

Designed by:



Antoine
France

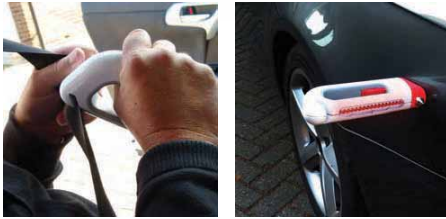

MT 355

XDDESIGN® Odin is the help you need during any car break down or even an accident. All necessary tools from safety light and torch to safety hammer and seatbelt cutter are combined in a robust body. Registered design®

ABS body, torch with 4 bright white LEDs and 4 strong magnets integrated in torch. Manual included.



**Ready
Stock**





Automobile
Accessories



Designed by :



Antoine
France

**Ready
Stock**

MT 356

XDDESIGN® Thor is an emergency Safety Hammer. If you ever need to smash your window, Thor will get you out. Registered design®



ALSO

Emergency red flashing light function



**Ready
Stock**

UD 773

Multi-Functional Rotational Car Charger

This device is a 3-in-1 car charger + power bank + torch.

Suitable for charging your car battery, laptop and mobile phones.

Perfect for travel, especially on road trips. Battery capacity: 1400 mAh

Customized Diaries



A5 Desk Diary
Vinyl hard case



A5 Desk Diary
Foam padded cover

CUSTOMISED



Pocket Diary

21 x 26 Diary (Executive)
Page A Day





Blanket - 200 GSM
 Size: 140 x 180 cm
 in polyester drawstring bag

XDDESIGN®

Designed by:



Ryan McSorley
 Ireland



UI 1262

XDDESIGN® Quad is a square marker in matt finish with 4 caps covering the markers in blue, yellow, orange and green. Registered design®



KT 011

Countdown time clock



DT 513

Digital Weight Scale Up to 500 gms (0.1 gm resolution)
 Auto power-off function, pocket size, used in offices (letters & postage), laboratories, jeweller etc.
 A must for every office / home.

JIND 072
 Acrylic Solid Footscale



Designed by:



Ryan McSorley
Ireland



UI 1275

XDDESIGN[®] Opto will help you avoid those annoying moments where you have trouble reading the small letters in a restaurant, bank, hotel, or any other place. The timeless design makes reading with glasses trendy again. Registered design[®]



Designed by:
Emma Sandberg
Sweden



XD | ECO



UI 1263

XDDESIGN[®] Timo can save up to twenty thousand litres of heated water per year by using Timo the eco friendly shower coach with strong suction cup. You'll save energy and reduce your power and water bill at the same time! Registered design[®]



Ready Stock

Designed by:



Antoine
France



WN 109

XDDESIGN[®] Vulcan helps you extinguish small fires in no time. The 1x1m fire blanket is stored in a well designed case that you can easily hang in your kitchen. This keeps the fire blanket available for immediate duty instead of keeping it in a drawer, should a fire brake out. Registered design[®]
Case in PP, blanket in fibre glass. Product is EN 1869 compliant, low cadmium and Azo free.

**Exclusive
Card Holders**

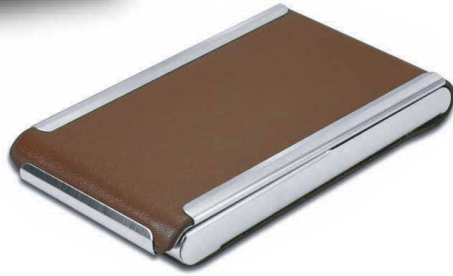

CH 136 Tan

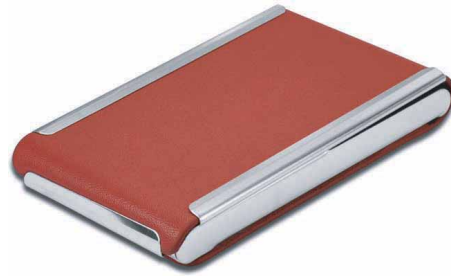

CH 136 Red

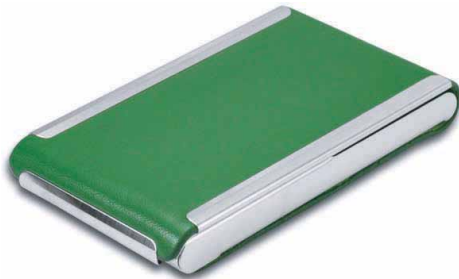

CH 136 Green

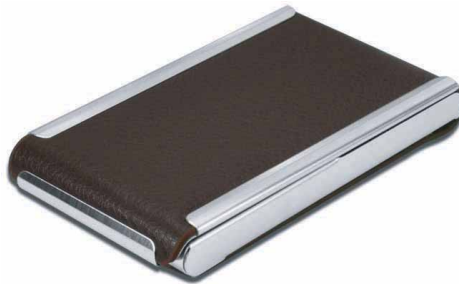

CH 136 Brown

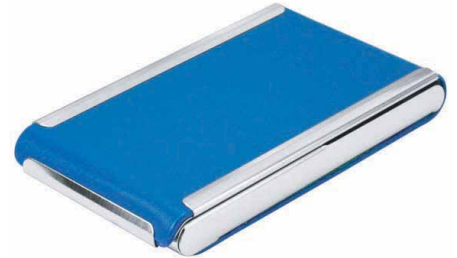

CH 136 Royal Blue



CH 136 Black



CH 136 Black Carbon look

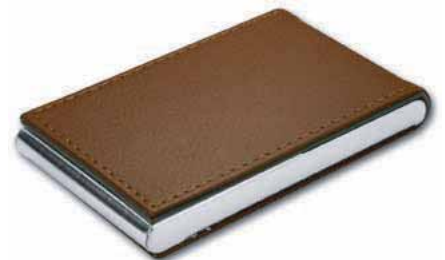

CH 138 Tan



CH 142
Gun Metal Finish



CH 140
Gun Metal Finish



CH 141
Gun Metal Finish



Ready Stock



CH 135 Black

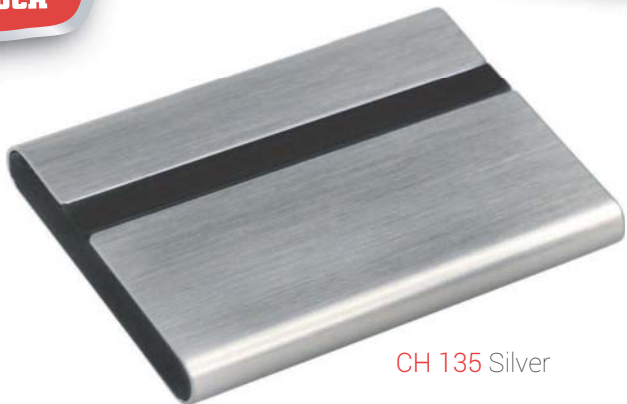

CH 135 Silver



CH 143 Dark Gun Metal
 Metal business Card Holder with Mesh casing



CH 143 Silver
 Metal business Card Holder with Mesh casing

CH 148
 PU Leather Card Case with 2 pockets
 for credit cards & 12 PVC Sleeves



UI 1276
 PU Leather note pad
 with 50 pages pad & pen

Ready Stock

UI 1267
 PU Leather small note pad with
 pen and 3 pockets for credit cards



Budget / Value
Metal / PU / Leather
Business Card Holders



CH 125



CH 126



CH 116
Black



CH 116
Brown



CH 149
Black



CH 128



CH 121



Burgundy

2166
Cow antique leather



2139
Soft sheep nappa leather
Option of Black & Red colors

XDDESIGN®



UI 1268

XDDESIGN® Prestige is an A5 notebook set with stylish fabric inside and outside, magnetic closure and metal plate. Inside there's an A5 notebook with 96 sheets for all your notes. Including complete stainless steel ballpoint pen. Registered design®

10 Days Delivery



MT 359

XDDESIGN® Eclipse Desk is a design Eco friendly LED torch, charged by solar power. With 4 LEDs, packed in magnetic gift box. Registered design®



reddot design award winner 2008



MT 360

XDDESIGN® Eclipse Mini is a well designed solar torch that can generate power to lighten the 2 bright LED's for 1 hour by using sun cell technology. Registered design®



10 Days Delivery



MT 361

Strong 1W outdoor light with a very strong aluminum body, including a Swiss Peak pouch. Registered®



MT 362

XDDESIGN® Cyla is a bright cylindrical torch with 9 white LED's so you will easily find your way through the dark. Registered design®

**Multi Utility
Torches & Sets**



GS 1201
LED torch with
Batteries and pen in gift box



MT 337
Pocket Torch
with detachable keyring.



MT 338
Torch Keylight
WEEE-compliant



MT 339
Bright LED Keyring
WEEE-compliant



MT 311
Torch with LED & Pointer light & Clock

Calculators & Multi Utility Tools

Ready Stock



DT 570
 10 digit desk calculator
 in champagne gold color



UD 704
 12 digit USB Calculator
 (Dual power, auto shut off),
 Dual usage - Calculator and Keypad

DT 507
 Stylish, slide-up pocket
 calculator with
 world time, perpetual
 calendar, alarm clock
 and music, ideal
 sleek travel gadget



MT 312
 Picnic set of
 fork & spoon



MT 313
 Multi -Tool



Blue

MT 303
 6 in 1 Screw Driver Kit



Black



MT 312&MT 313
 Available only as a set in tin box
 packaging

Multi Utility
 High Quality Tools

25 IN 1 Stainless Steel Multi Tools 6 1/2"

(Manufactured in accordance with U.S. Federal and ANSI specifications.)
 in Real Leather Pouch

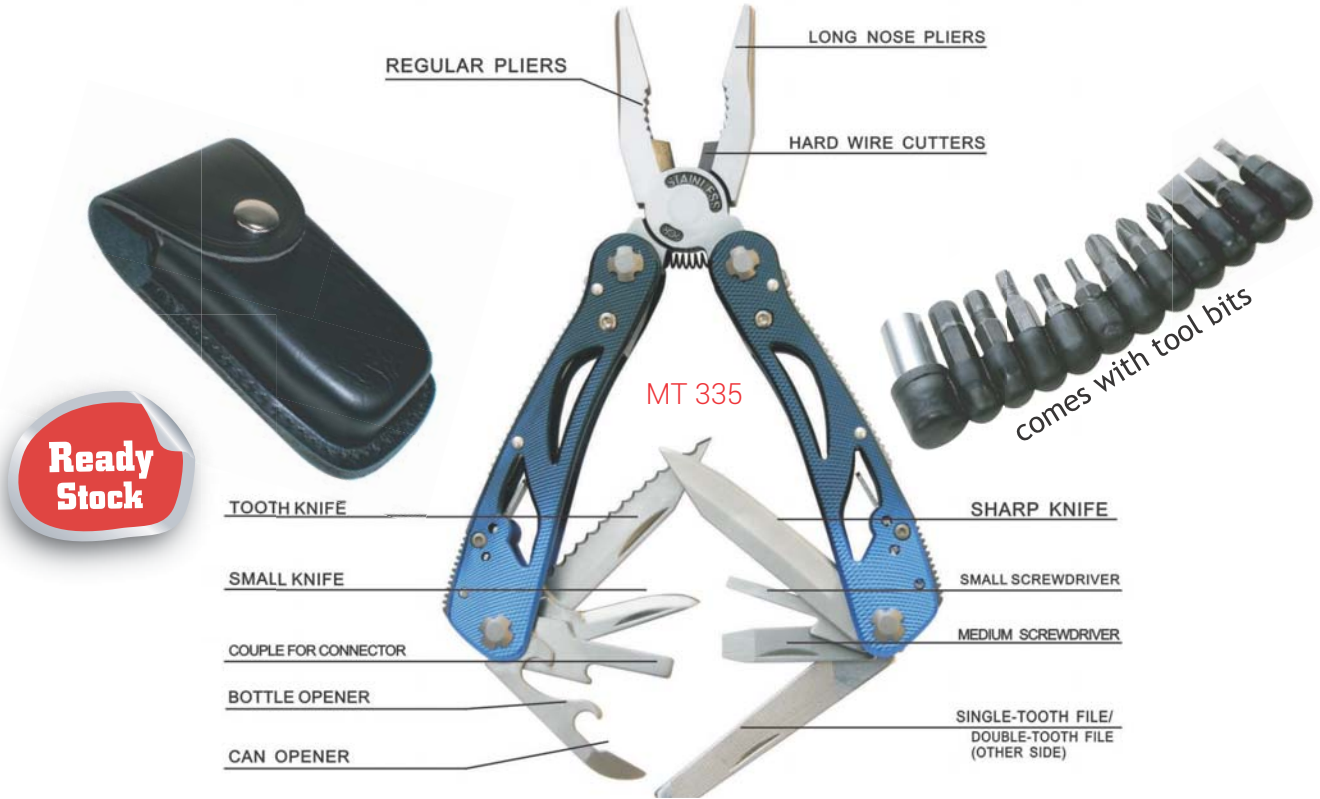

9 IN 1

Multi Purpose Tools with LED Light

(Manufactured in accordance with U.S. Federal and ANSI specifications.)
 in elegant Tin Box.



Ready
 Stock

MT 327

XDDESIGN®



White / Blue



Grey/Lime

MT 354

XDDESIGN® Tovo is the ultimate multitool for the Urban adventurer. The sleek handle in combination with the stainless steel tools provide a complete new look and feel. The multitool is supplied with a neoprene pouch and carabiner so it can be stored and hooked anywhere.

No obstacle is too big anymore with this tool's elaborate 16 functions. Registered design®

Designed by :



Antoine
France



White / Blue



Grey/Lime



MT 358

XDDESIGN® Tovo Junior is the ultimate pocket knife for the Urban adventurer. The sleek handle in combination with the stainless steel tools provide a complete new look and feel.

The pocket knife has an integrated carabiner so it can be conveniently hooked anywhere. With its 10 functions, no obstacle is too big for this tool. Registered design®

Designed by :



Antoine
France

PGA TOUR Polo Shirts
 & PGA TOUR Barbeque Set



NanoBon
 Is an amazing absorbent fiber because of the high quantity of micro holes. Due to strong moisture absorbency and breathability it eliminates perspiration.

Minus Ion
 The effect of this fiber will come free due to the light friction between body and air. This Minus Ion cleans the air and is considered as an "Air Vitamin"

Far Infrared Ray Effect
 This Ray comes free from the fiber and is an element of sunlight. This promotes the circulation systems in the human body and maintains a constant body temperature.



Bamboo Navy

Ace Jacquard Polo with Bamboo

2 - Tone fabric of 65% polyester and 35% rayon nanobon.
 2 Button placket with embossed buttons. 1x1 flat knit rib collar. Necktape. Side slits. PGA tour print at the sleeve.
 S-XXL

Bamboo Green



TA 105

PGA Tour BBQ Golf Bag Set
 Spatula, Meat Fork, Basting Brush,
 Grill Brush & Tweezers-all golf designed in a
 Golf design bag. 14x15x45 cm.

Ref.	GOLF POLO - Limited Edition
Item	Premium Polo in Pre-dyed Yarn
Best For:	Executive wear; As Golf Polos
USP	Premium Quality Comparable To Top Brands Performance For Colour Fastness, Shrinkage And Shape Retention - Wash After Wash Elegant Style!
Legend	
1	Collar is High Quality Jacquard in yarn dyed. Main label of high quality.
2	Collar Band in biased contrast stripes matching to body.
3	Placket in biased contrast stripes matching to body
4	Premium thick trendy buttons.
5	Base fabric is End-on-End Pre-dyed yarn

Look for This Label



Purple - toned Burgundy



Sky Blue



Navy blue



Anthra



GA 4025

Holds 2 balls, 3 tees and 1 pitch repairer



GA 104

Three fold Golf Towel



MT 353

Multi Golf Tool kit with tees



GA 102A

Amateur golf kit in PU case



GA 120

Flaunt your love of golf with your own mini golf course. Get amateur putting practice in the office or play with children at home, while teaching them the basics of golf.

Sporting Goods
Customised

FOOT BALL - SIZE 5



FOOT BALL - SIZE 1



COUNTRY BALL



TRAINING SET



RUGBY BALL

Sporting Goods Customised



BASKET BALL



VOLLEY BALL



Ladies Gifts



UI 1255
 Exclusive Manicure set in aluminum case



UI 1202
 Ladies Manicure Exclusive set guaranteed gold plating. Elegant PU coated case.



BALMAIN
 PARIS

BALMAIN 21" 3-SECTION UMBRELLA
 3-section umbrella with contrasting edge and the handle is with an imitation leather finishing
 95 x 25.5 cm

Ready Stock



SP 303
 Pen with Swarovski elements

PB 1003



6400
 BALMAIN smartphone case with section divider.
 Size: 7.5 x 12.5 cm



Rust

6401 - Cow antique leather



Dark Brown



Tan / Cognac

Real Leather
 High Quality
 Ladies Wallets

**Ready
 Stock**



PB 1011



1218



PB 1016

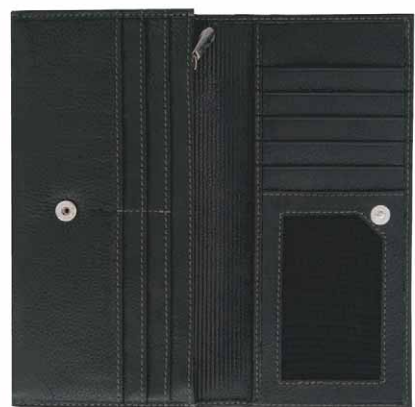

15316



PB 1016



1217



Colours available:



Black with exotic Dark Grey contrast stitch.



Maroon with melting Cream color stitching.

Details - Black wallets have an exotic Dark Grey contrast stitch; Maroon wallets have melting cream color stitching.

Leather - Cow Milled Nappa - Fine Touch

**Real Leather
Ladies Wallets & Sets**

1235 YDM Black
+ UD 723



UD 723
Available in 2 GB, 4 GB, 8 GB,
16 GB & 32 GB. Original SAMSUNG
memory chip is used in this
flash memory USB stick.

1235 YDM Black
Leather - Cow PDM



Black

1233
Real Leather Ladies wallet
with zipper pocket to hold coins



Maroon

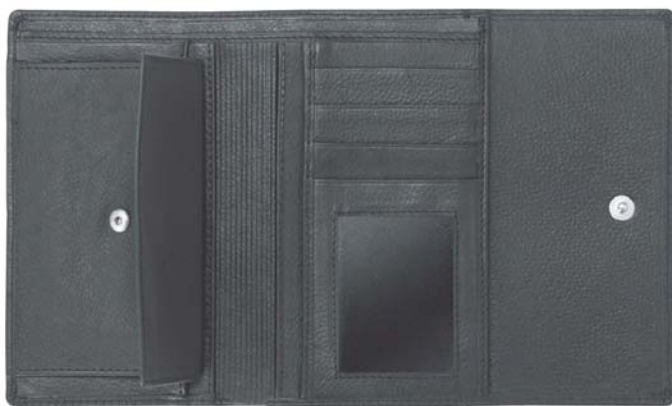

1235 YDM Black
Leather - Cow PDM



1235 YDM Brown
Leather - Cow PDM

**Real Leather
 Mens Wallet & Sets**

S251 Black *Leather - Cow PDM*
 YDM



1071 Black
 YDM



Leather - Cow PDM
 The flap is detachable
 from the wallet



**Ready
 Stock**



Leather - Cow PDM

S251 Brown
 YDM



1071 Brown
 YDM

Leather - Cow PDM

The flap is detachable from the wallet

S251 Black YDM + UD 751 Black



Leather - Cow PDM



UD 751 Black

A twister with a difference,
 unique flat and sharp design
 gives this USB a modern and trendy appearance.
 Available in 2 GB, 4 GB, 8 GB, 16 GB & 32 GB

AS 02 Black + KC 2026



Leather - Cow Softy



KC 2026

**Real Leather
 Mens Wallets & Sets**

AS 03 Black
Leather - Cow Softy



AS 04 Black
Leather - Cow Softy

AS 02 Black
Leather - Cow Softy



Double contrast stitching



AS 05 Black *Leather - Cow Softy*



AS 06 Black *Leather - Cow Softy*

AS 03 Black + MP 854 + UD 706 Black

AS06 Black + MP 860 + KC 1343



UD 706 Black
 Available in
 2 GB, 4 GB
 8 GB, 16 GB
 Original SAMSUNG
 memory chip is used
 in this flash memory
 USB stick.

MP 854



MP 860



KC 1343



AS 03 Black *Leather - Cow Softy*



AS 06 Black *Leather - Cow Softy*



6304

Passport Holder

Smart design with provision to hold credit cards & 2 sim cards.

Leather - Cow Antiquated Finish

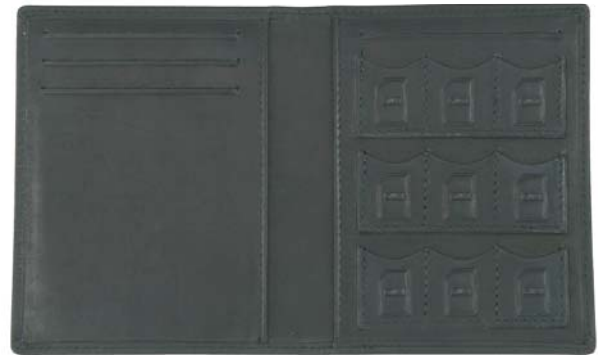

6305

Sim Cards Holder for frequent travellers holding sim cards of various mobile service providers & countries; additional pockets to hold credit cards

Leather - Cow Antiquated Finish



CW-2C FC Black

A widely - used wallet style ; basic functionality of holding credit cards & coins.

Leather - Sheep FC nappa



1134 FC Black

As basic & simple as a wallet can get. Holds credit cards.

Leather - Sheep FC nappa

Santhome
Men's Wallets

Ready
Stock



6018



6016



6017





6018 + MP 662 + KC 1343



KC 1343 MP 662



6018



6016 + UD 745



UD 745



6016

6017 + KC 1343



KC 1343



6017

Leather: High - end synthetic

SANTHOME

**Budget / Value
 Desktops & Desk Clocks**

DT 609

Executive Name Card Cum Cellphone Holder



UI 1277

Executive PU Leather Memo Pad Case

**Ready
 Stock**



DT 548

Budget Memo & Pen Holder

MT 307

4 in 1 Office Compact Organiser

with 8 digit calculator (foldable), stainless steel scissors (retractable). stapler (no.10 staples). measure tape, storing case for staples or clip-pins.



DT 501

PU Clock + Thermometer + Hygrometer

Budget / Value
 Desktops & Desk Clocks

**Ready
 Stock**



DT 596
 Alarm clock, Photoframe, Pen holder



DT 600
 Alarm clock with wide logo space



DT 646
 Desktop Clock with Maze Game

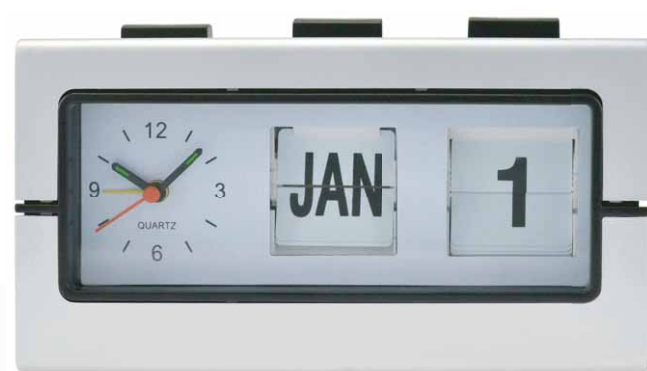

DT 597
 Alarm clock, Date, Month



DT 571
 Desk clock with day function,
 snooze function, pens & clips holder,
 3 modes of alarm to choose



DT 647
 Clock with Photoframe;
 Spring grip holds Paper Notes & Business cards

Metal Wall Clocks

WC 211 Metal
12" Clock



WC 210 Metal
12" Clock



**Ready
Stock**

WC 204 Metal
12" Clock



WC 205 Metal
12" Clock



WC 218 Metal
12" Clock-Black



WC 218 Metal
12" Clock-White



WC 217 Metal
10" Clock-Black



WC 217 Metal
10" Clock-White





WC 206
 14" Clock, Thermometer,
 Hygrometer



WC 207
 14" Clock, Thermometer,
 Hygrometer



WC 121 B



WC 121 G

Plastic quartz- clock with
 thermometer & hygro meter,
 black dial, front logo space
 Size: 12"



WC 121 R



WC 121 W

High Quality
Metal Desktops

Ready
Stock



ED 433



ED 434



ED 429
Aluminium Clock & Pen holder



ED 430
Aluminium Clock with Pen & Clips Holder

**Ready
Stock**

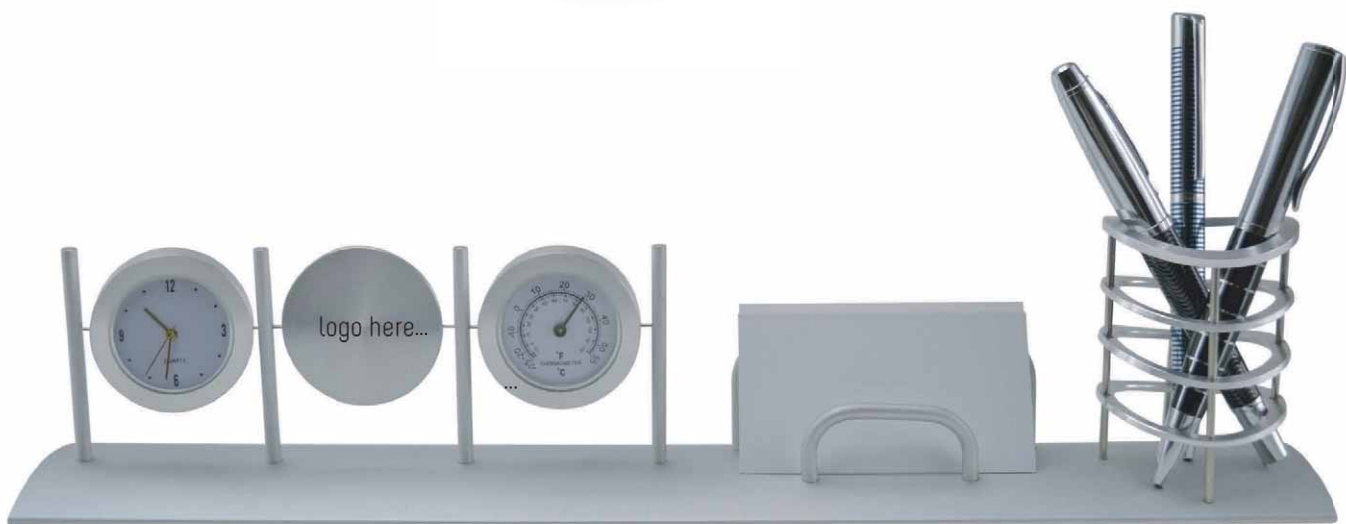

ED 451
Aluminium Desktop set with Clock,
Thermometer, Pen stand and Business card holder

Quality Wooden /
Metal Desktops



TC 644
Wooden Table Clock.
Dimensions: 9 x 5.8 x 18.3 cm



DT 594
Metal & Wooden Combination Table Clock
with Business Cards Holder



TC 645
Wooden Table Clock.
Dimensions: 10.5 x 9.5 x 8.5 cm



DT 595
Metal & Wooden Combination Table Clock
with Business Cards Holder & Additional Temperature Indicator

Quality Wooden
Desktops



DT 605

Uniquely shaped Wooden Table Clock, Thermometer, Hygrometer and Pen Stand

Ready
Stock



DT 606

Wooden Table Clock and Thermometer with a pen holder and easily accessible notes pad



DT 584

50 yrs calendar



TC 617

Wooden Table Clock



Quality
Desktops

Ready
Stock



DT 579



ED 424



ED 426

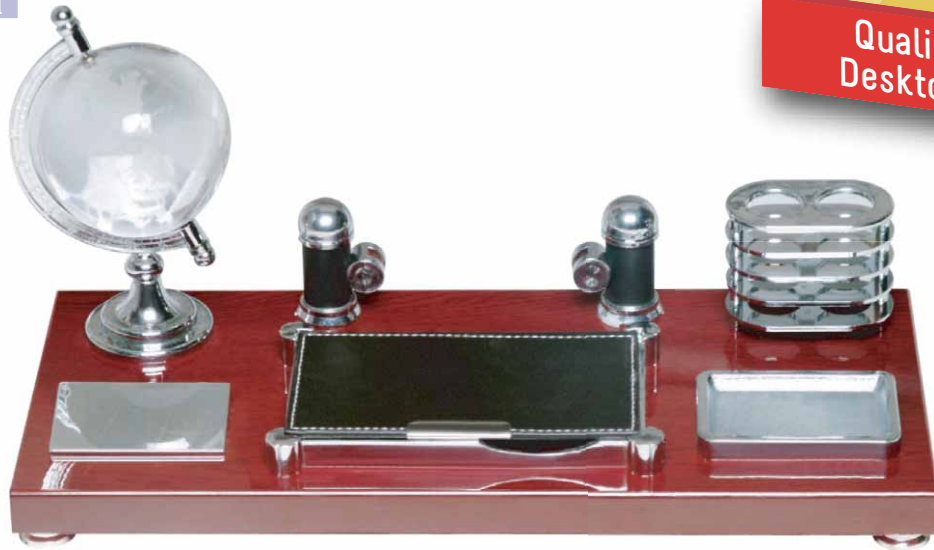

ED 425



DT 576

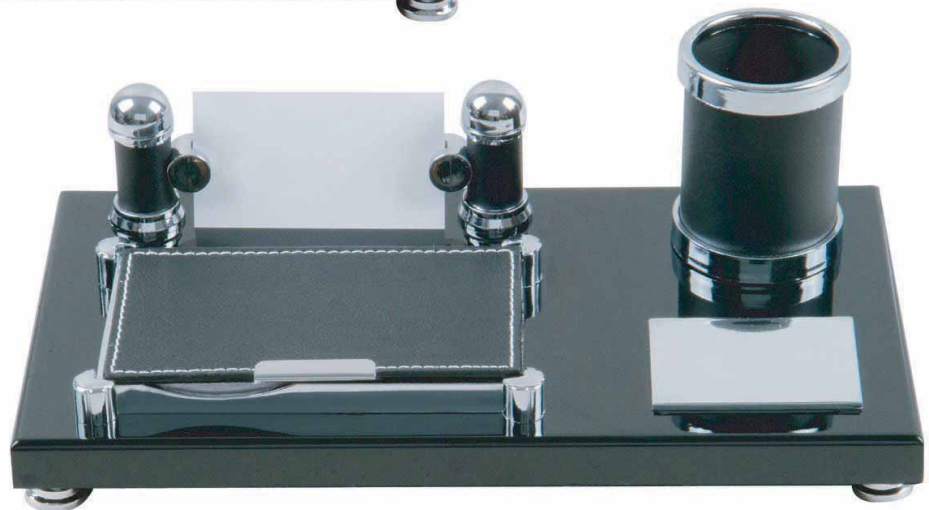

DT 578



DT 577

Exclusive
High Quality Desk Sets



DT 524
Set of 5 Items



DT 525
Set of 4 Items
Crocodile Skin Look PU Desktop



Exclusive
High Quality Wooden &
PU Combination Desk Set

**Ready
Stock**



DT 590 - A Designer Desk Set !

Set of 5 exclusive desk accessories.

Rich Walnut color.

Pad, A4 In - out tray, Magnetic clip & pin holder,
Scribbling pad & Envelope & Pen stand

**Ready
Stock**



DT 607 - Designer Desk Set in smooth finishing !

Set of 5 exclusive accessories -

Mouse Pad, Notes Holder,

Pen Stand, Display Stand and Writing Pad.

Exclusive
High Quality Metal Deskset
& Photo Frame



**Ready
Stock**



DT 575

Set of 4 exclusive desk metal accessories

**Ready
Stock**

DT 592

Metallic photo frame with
stainless steel top in shiny finish. 5" x 7"



Exclusive
High Quality Metal Deskset
& Photo Frame

**Ready
Stock**



DT 586
Set of 5 items
Metal desk accessories including
pen holder, clock, business card holder,
2-hole punch & stapler # 10

**Ready
Stock**

DT 593
Metallic photo frame with
stainless steel top in shiny finish. 4" x 6"



Exclusive High Quality
Metal & Silver Plated
Desktops



TC 612

Heavy brushed metal case with crescent alarm movement
Product size: 86 mm Dia x 35 mm Packing:
Recycled Paper Gift Box



DT 536

Silver plated Desk Clock

TC 626

3-axle gyro spinning mag globe clock
in 3600 with slanted base for
logo imprinting & photoframe.
Product size: 98.4(l) x 93(w) x 93.5(h)mm.
Packing: Recycled paper gift box.



**Ready
Stock**

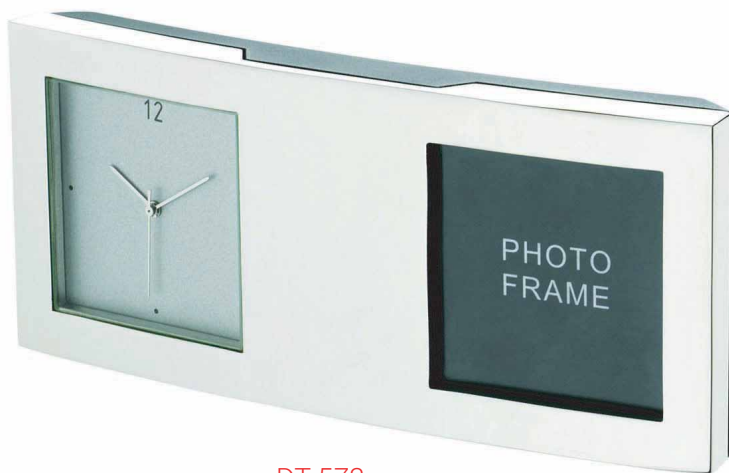

DT 573

Metal desk quartz clock
with a photo frame



DT 537

Silver plated Business Cards Holder

Exclusive
High Quality Wooden /
Metal Desktops & Wallpieces

TC 649

3-axle gyro 360° spinning mag globe +
photo frame (fits 40mm dia. (1-1/2") photo or logo) +
wooden frame with metal trim +
engraving plate + 1 x SR626SW battery included.
Product size: 108(l) x 53(w) x 108.5(h)mm; 289g (nw)
Packing: Recycled paper gift box



**Ready
Stock**

WM 701

Weather station - wall hanging - with barometer
thermometer & hygrometer - wooden frame

Exclusive
 High Quality
 Metal Deskpieces

**Ready
 Stock**

Storage
 Compartment



TC 653

An Exclusive 'Flying the Aircraft' feel,
 "Cockpit" Metal + Wood Duo Time Weather Station Desk Set
 Solid wood cased with heavy metal dual time weather station
 + Thermometer (in °C and °F) + Hygrometer + Concealed storage compartment
 + Engraving plate included +2 x LLR44 battery included
 Product size: 300(L) x 105(W) x 60(H)mm; 920g (NW)
 Packing: recycled paper gift box

Black

**Ready
 Stock**

Silver



TC 660

GMT World Timer with Turning Plate Time Zone
 Selector in Matt Black with Engraving Plate.
 A Collector's piece for every desk.

Awards & Trophies Don't Get Better !!!



TC 643
 Analog Clock cum Award.
 Black dial
 Product size: 245.5 x 79.5 x 61 mm.
 Seiko PC21S Quartz
 3 Hands movement



TC 642
 Analog Clock cum Award.
 White dial
 Product size: 245.5 x 79.5 x 61 mm.
 Seiko PC21S Quartz
 3 Hands movement



TC 650
 3-axle gyro spinning globe clock in 360° +
 photo frame (fits 40mm (1-1/2" dia.)
 photo or logo) + wooden base + engraving plate +
 1 x SR626SW battery included
 Product size: 84(l) x 68(w) x 144.5(h)mm; 340g (nw)
 Packing: Recycled paper gift box

TC 651
 3-axle gyro spinning globe clock in 360° +
 photo frame (fits 40mm (1-1/2" dia.)
 photo or logo) + wooden base + engraving plate +
 1 x SR626SW battery included
 Product size: 84(l) x 68(w) x 144.5(h)mm; 340g (nw)
 Packing: Recycled paper gift box

Exclusive
High Quality
Metal Desktops



TC 652

Heavy brushed steel finish see thru' clock +
wall mounted or desktop use + 1 x LR1154 battery included
Product size: 125 x 22mm; 350g (nw)
Packing: recycled paper gift box

**Ready
Stock**



DT 574

Stainless steel & plastic combination
dual face analog digital clock & a logo plate

Exclusive
 High Quality
 Metal Desktops



TC 633

Foldable metal alarm clock
 Heavy zinc alloy polished & plated case +
 crescendo alarm movement + engraving plate
 product size: 60 x 29.5mm

**Ready
 Stock**



DT 572

Metal quartz clock, business cards holder &
 pen as a one piece combo



TC 614

3-axle gyro spinning globe in 360° with photoframe
 (40 mm Dia picture) Product size: 133 x 93 x 72 mm
 Packing: Recycled Paper Gift Box



Silver

TC 615

3-axle heavy metal spinning clock in 360°
 with photoframe in foldable metal case
 Product size: 77.5 mm Dia x 11 mm(H) x 89 mm
 Packing: Recycled Paper Gift Box



Exclusive
High Quality
Metal Desktops



TC 648

2-axle gyro 360° spinning mag globe +
photo frame (fits 40mm dia (1-1/2")
photo or logo) + wooden base + engraving plate +
1 x SR626SW battery included
Product size: 210(1) x 79(w) x 95(h)mm; 428(nw)
Packing: recycled paper gift box

**Ready
Stock**



ED 421

Product size: 217mm length X
11 mm width X165mm height
packing: recycled paper gift box
gyro 3- axle 360o spinning mag globe 80mm
with pen set on wood base dual time & photo frame.



Ready Stock



TC 639

Heavy brushed metal chrome clock with rotating world-time indicator. Crystal-transparent cut-glass base (laser engravable). Enjoyable spinning motion of the globe on glass base. Executive design.



TC 641

"Timekeeper" - Metal Analog Desk Clock with engravable metal base. The case is zinc alloy with mineral glass lens. Perfect timepiece for any office desks.



TC 640

Personalized rotary clock (with multi-angle photo frame and imprint disc) that can be turned to create unique shapes. Heavy solid metal with shiny plated finishing.

Lamborghini
Silver Collection



by *Tonino Lamborghini*



FOSSE - 98179-10
Silver plated luggage tag with golf pitcher

**Ready
Stock**



L001
Silver plated CD rack



FERRUZZANO - 98194-19
Silver plated metal business card holder



by *Tonino Lamborghini*



STAITI - 98193-19
Silver plated foldable clock



FIUMARA - 98195-19
Silver plated mouse pad

Quality Coasters



DT 526
Set of 6 Coasters



DT 561
Ceramic Coasters
Set of 4 in paper box



DT 527
Set of 6 Coasters



DT 580
Plastic set of 6 coasters
centre piece with metal for
printing / engraving

DT 591
Gun Metal with PU
Combination Coaster
(Single coaster only)



DT 528
Set of 4 Coasters



DT 562
Set of 6 Coasters



SANTHOME

Set 35

Elegant PU Leather gift set with men's wallet , key holder & ball pen



SANTHOME

Set 37

Elegant PU Leather gift set with passport holder, wallet & pen



GS 1206

Card Holder and Keychain Set

Gift Sets



by *Tonino Lamborghini*



MONICA - 984422 GIFT SET
Set of Ladies Wallet in black full grain leather and Ballpoint Pen.

**Ready
Stock**

BALMAIN
PARIS

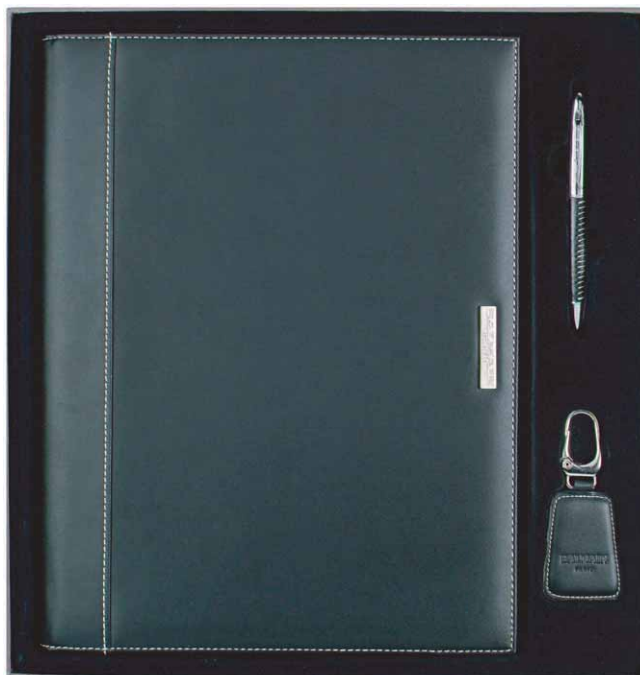

SET 26 - BALMAIN Portfolio Set
Combined set with portfolio, keychain and leather ballpoint
35.5 x 37 x 3.5 cm

222



BALMAIN

PARIS

- » PCP Compliant
- » Formaldehyde Compliant
- » AZO Compliant



SET 25 - BALMAIN Gift Sets
Leather wrapped ballpoint with keychain and wallet in gift box.



BALMAIN

PARIS

SET 33 - BALMAIN Gift Sets
Contrast stitching notebook and leather wrapped ballpoint, both presented in a matching gift box

BALMAIN

PARIS



SET 34 - BALMAIN Gift Sets
BALMAIN Gift Set. Timeless set with ballpoint and A6 reference notebook with contrast colour stitching in a gift box

**Tonino Lamborghini
Gift Sets**



by *Tonino Lamborghini*



POZZI II - 981023 GIFTSETS

Set of Analogue Watch with stainless steel case and strap, 5 ATM, PU strap, Japan movement and Metal Ball Pen. blue ink Lamborghini refill.



ANTONY

Set of name card holder in black full grain leather and ball pen, Lamborghini blue ink refill.



JULIO

Set of cards + key holder in black top quality leather and ball pen, Lamborghini blue ink refill



by *Tonino Lamborghini*

**Tonino Lamborghini
Gift Sets**



**Ready
Stock**

PISA - 981178 GIFT SET

Set of Ladies Watch with stainless steel case and strap, dial in mother of pearl, and Metal Ball Pen. blue ink.



PISA - II GIFT SET

Set of ladies watch with stainless steel case and strap, dial in Mother of Pearl and metal ball pen. blue ink



ALBERTO III - 981448 GIFT SET

Set of Analogue Watch with stainless steel case. 3 ATM, Leather Strap, and Metal Ball Pen. blue ink.

Santhome
 Made in Germany
 Real Leather Gift Sets



6001
 Frankfurter

PB 1011 - Box



6001 Tan

6001 Black

6001 Green

**Ready
 Stock**

6001

Genuine Leather.
 Article crafted & made in Germany.
 An A - 7 pocket note - pad holder
 with a pen for jotting down.



SANTHOMÉ
 MADE IN GERMANY



6901
 Munchen

PB 1011 - Box



**Ready
 Stock**

6901

Genuine Leather.
 Article crafted & made in Germany.
 A mobile phone holder designed to
 hold various currently used mobile
 phone instruments.



6301
 Flughafen

PB 1017 - Box



6301 Brown



6301 Black

6301

Genuine Leather.
 Article crafted & made in Germany.
 A Travel wallet - elegant & practical

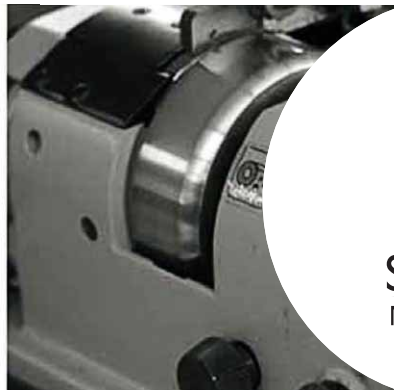

SANTHOMÉ
 MADE IN GERMANY



PB 1033 - Box

6902 Koln



6902 Tan



6902 Brown

6902

Genuine Leather.
 Article crafted & made in Germany.
 A Kit for Shoe - Care articles; quality beyond compare; A collector's edition !



6902 Black

Santhome
 Made in Germany
 Real Leather Gifts



PB 1025- Box

Ready Stock

6603
 Berliner



6603 Tan



6603 Black

6603

Genuine Leather.

Article crafted & made in Germany.

A Briefcase for Leaders - Handy,
 Light - weight, exudes class, Amiiet
 Switzerland Lock

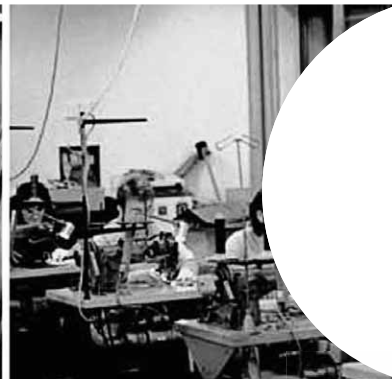
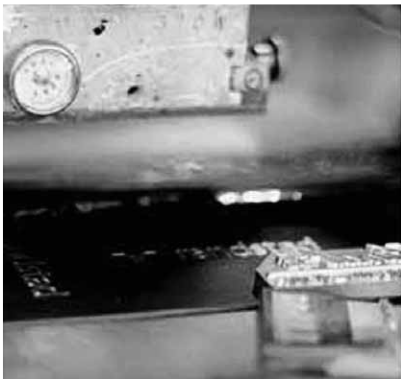

SANTHOMÉ
 MADE IN GERMANY



PB 1023- Box

6602
 Zurich



6602 Tan



6602 Black

Ready Stock

6602

Genuine Leather.

Article crafted & made in Germany.

Hand - clutch documents case -
 elegant in its simplicity.



6601
 GENEVE



6601 Tan



6601 Brown



PB 1032- Box



6601 Black



6601

Genuine Leather.
Article crafted & made in Germany.
An A5 folder for the executive on the move.

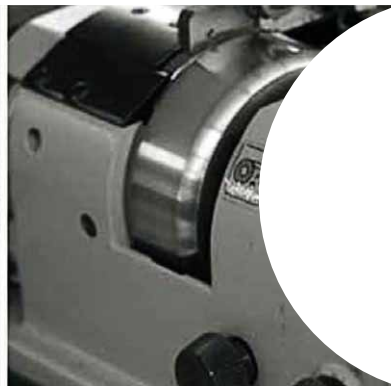

SANTHOMÉ
 MADE IN GERMANY

6604
 Maximum

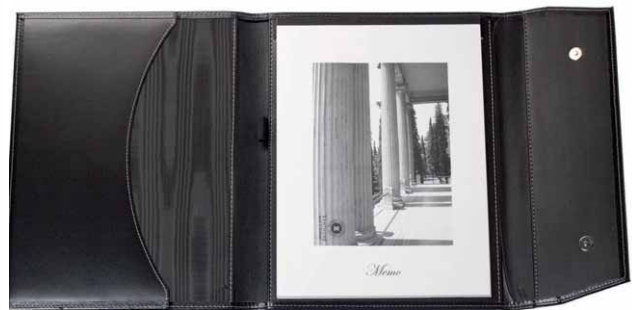

6604 Black

PB 1023- Box



6604 Tan

6604

Genuine Leather.
Article crafted & made in Germany.
A4 folder - 3 fold - for when you must act decisively and swiftly.



Santhome
 Made in Germany
 Real Leather Gift Sets



PB 1013- Box

6901 &
 SP 303



SP 303

Ready Stock



6901

6901 &
 SP 303

An exquisite ladies set; a mix of German leather and craftsmanship with Swarovski elements.

6901

A mobile phone holder designed to hold various currently used mobile phone instruments.

SP 303

Pen with Swarovski elements.



SANTHOMÉ
 MADE IN GERMANY



PB 1013- Box

6901 &
 MP 833



MP 833

Ready Stock



6901

6901 &
 MP 833

Classy elegant SANTHOMÉ pen with a SANTHOMÉ real German leather mobile phone holder

Santhome
 Made in Germany
 Real Leather Gift Sets

Ready Stock



6001 &
 UD 745

PB 1013



6001 Black



UD 745
 Black



6001 Tan



UD 745
 Tan

6001 & UD 745	Tradition meets technology! A leather pocket note-pad holder - traditional to the core! meets a modern daily - use technology product - Memory flash drive.
6001	An A-7 pocket note - pad holder with a pen for jotting down.
UD 745	Available in 2 GB, 4 GB, 8 GB, 16 GB & 32 GB. Original SAMSUNG memory chip is used in this flash memory USB stick.



SANTHOME
 MADE IN GERMANY

Ready Stock



6901 &
 6001

PB 1015



6901	A mobile phone holder designed to hold various currently used mobile phone instruments.
6001	An A-7 pocket note - pad holder with a pen for jotting down.



Santhome
 Made in Germany
 Real Leather Gift Sets



6001 &
 VERIMELLI
 13117B



6001
 Black



VERIMELLI
 13117B



**Ready
 Stock**

PB 1014

6001 & VERIMELLI 13117B	A unique unisex gift set comprising of the 'Made in Germany' A-7 pocket note - pad holder & the 'Italian' Lamborghini keyholder.
6001	An A-7 pocket note - pad holder with a pen for jotting down.
VERIMELLI 13117B	Lamborghini Keyholder

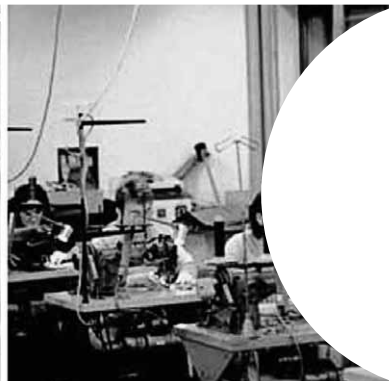
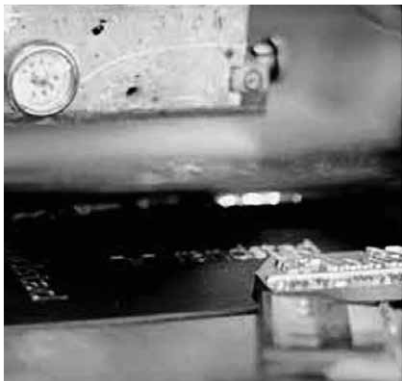

SANTHOME
 MADE IN GERMANY



6901 &
 VERIMELLI
 13117B



6001 & VERIMELLI 13117B	A unique unisex gift set comprising of the 'Made in Germany' mobile phone holder & the 'Italian' Lamborghini keyholder
6901	A mobile phone holder designed to hold various currently used mobile phone instruments
VERIMELLI 13117B	Lamborghini Keyholder

232

PB 1014

**Ready
 Stock**



6301 & 6001



Ready Stock

PB 1020

6301 Black



6001 Black



6301	Elegant Travel Wallet
6001	An A-7 pocket note - pad holder with a pen for jotting down.



SANTHOMÉ
 MADE IN GERMANY

6301 & 6901



Ready Stock

PB 1020

6301 Black



6901 Black



6301	Elegant Travel Wallet
6901	A mobile phone holder designed to hold various currently used mobile phone instruments.

6301 & UD 745

PB 1021



Ready Stock

6301 Black



UD 745 Black

6301	Elegant Travel Wallet
UD 745	UD 745 Available in 2 GB, 4 GB, 8 GB, 16 GB & 32 GB. Original SAMSUNG memory chip is used in this flash memory USB stick.

Santhome
 Made in Germany
 Real Leather Gift Sets

6601 & MP 868

Ready Stock

Platignum
 LONDON 1919



PB 1027



6601 Black



MP 868

6601	An A5 folders for the executive on the move.
MP 868	Platignum metal pen



SANTHOMÉ
 MADE IN GERMANY

6604 , MP 669 &
 UD 745

Ready Stock



PB 1024



6604 Black



MP 669



UD 745
 Black

6604	An A-4 folder for the decision - maker
MP 669	A collector's delight !
UD 745	Available in 2 GB, 4 GB, 8 GB, 16 GB & 32 GB. Original SAMSUNG memory chip is used in this flash memory USB stick.



6303 Purple Patch



PB 1011



Purple stitching and punched design

6303 Purple Patch
 This passport holder is created using various textures & colors of Genuine Leather.
 Outside - Punched design; Genuine Leather cow nappa Black.
 Inside - Traditional Cow Nappa Black
 Purple Patch - Cow Nappa, again ! The monotony breaker!
 Inner fabric is suave & premium in quality.
 Purple threads run through the wallet & complete the picture

6303 Purple Patch & SP 303



PB 1013



Purple stitching and punched design



SP 303
 Made with Swarovski elements

6303 Purple Patch
 This passport holder is created using various textures & colors of Genuine Leather. Outside - Punched design; Genuine Leather cow nappa Black.
 Inside - Traditional Cow Nappa Black
 Purple Patch - Cow Nappa, again ! The monotony breaker!
 Inner fabric is suave & premium in quality.
 Purple threads run through the wallet & complete the picture.

SANTHOME
 GENUINE LEATHER

**Santhome
 Real Leather
 Ladies Collection**

**Ready
 Stock**

6019 Purple Patch



Purple stitching and punched design



6019 Purple Patch

This wallet is created using various textures & colors of Genuine Leather. Outside - Punched design; Genuine Leather cow nappa Black. Inside - Traditional Cow Nappa Black Purple Patch - Cow Nappa, again! The monotony breaker! Inner fabric is suave & premium in quality. Purple threads run through the wallet & complete the picture.

PB 1011



PB 1015



6012 Purple Patch
 Business & Credit cards case

**6303 Purple Patch &
 6012 Purple Patch**



6303 Purple Patch
 Passport Holder for the lady on move.

**Ready
 Stock**

SANTHOMÉ
 GENUINE LEATHER

6303 Blue Blood



PB 1011



Blue stitching and punched design



6303 Blue Blood

This passport holder is created using various textures & colors of Genuine Leather

Outside - Punched design; Genuine Leather cow nappa Black.

Inside - Traditional Cow Nappa Black

Striking Blue Patch - Cow Nappa, again !The monotony breaker! Inner fabric is suave & premium in quality.

Striking Blue threads run through the wallet & complete the picture.

6019 Blue Blood



PB 1011



Blue stitching and punched design



6019 Blue Blood

This wallet is created using various textures & colors of Genuine Leather.

Outside - Punched design; Genuine Leather cow nappa Black.

Inside - Traditional Cow Nappa Black.

Blue Patch - Cow Nappa, again !The monotony breaker! Inner fabric is suave & premium in quality.

Striking Blue threads run through the wallet & complete the picture.

Santhome
 Real Leather Mens
 Gift Sets

Ready Stock

6303 Blue Blood, 6019 Blue Blood & 6012 Blue Blood



Blue stitching and punched design

A set of Mens Requisites
 Wallets to hold money & cards.
 Cards Case to hold business cards & credit cards
 Passport holder to hold passport & credit cards.
 All in Genuine Leather.
 Outside - Punched design; Genuine Leather cow nappa Black.
 Inside - Traditional Cow Nappa Black.
 Blue Patch - Cow Nappa, again ! The monotony breaker!
 Inner fabric is suave & premium in quality.
 Striking Blue threads run through the wallet & complete the picture.

PB 1019



6012 Blue Blood



6019 Blue Blood



6303 Blue Blood



PB 1013

6019 Blue Blood & MP 856 Blue

6019 Blue Blood & MP 856 Blue
 856 Blue
 SANTHOMÉ set of
 Genuine Leather Wallet
 (Blue Contrast) & elegant
 Blue Pen



MP 856 Blue



6019 Blue Blood

Ready Stock

SANTHOMÉ
 GENUINE LEATHER

6306



PB 1011

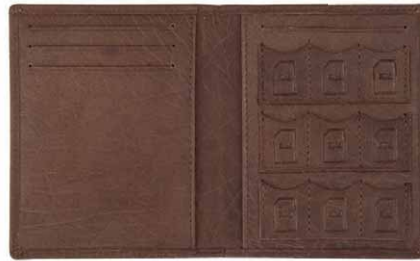

6306 - Sim Holder
An organizer for mobile sim for the 'countries - & - continents hopper.'

Ready
Stock

6307



PB 1011



6307 - Passport Holder
The standard international size.

Ready
Stock

6020



PB 1011



6020 - Credit Cards Case
Organizes various credit cards, identity cards, etc.

Ready
Stock

Leather: Buff - Drum Tumbled, Dry Dyed

SANTHOMÉ
GENUINE LEATHER

Santhome
 Real Leather Articles

Ready Stock

6307 & 6306



PB 1015

6307 & 6306
 A unique set, one-of-a-kind.
 A sim organizer with passport holder.

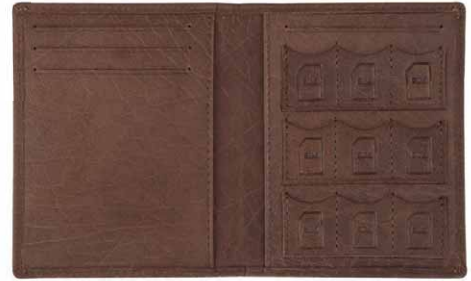

6306 - Sim Holder
 An organizer for mobile sim for the 'countries - & - continents hopper'



6307 - Passport Holder
 The standard international size.

6307, 6306, 6020



PB 1019

6307, 6306, 6020
 Add a cards case to the above set, & that is a comprehensive, & well - thought of gift set!



6306 - Sim Holder
 An organizer for mobile sim for the 'countries - & - continents hopper'



6307 - Passport Holder
 The standard international size.

Ready Stock



6020 - Credit Cards Case
 Organizes various credit cards, identity cards, etc.

Leather: Buff - Drum Tumbled, Dry Dyed

SANTHOMÉ
 GENUINE LEATHER



FO 3262 + SP 301
 + UD 745



FO 3262
 High - end material A4 folder
 with a modern elastic closure.

SP 301
 Stylus - cum - pen,
 modern design.



UD 745
 Available in 2 GB, 4 GB, 8 GB,
 16 GB & 32 GB. Original SAMSUNG
 memory chip is used in this
 flash memory USB stick.

PB 1024

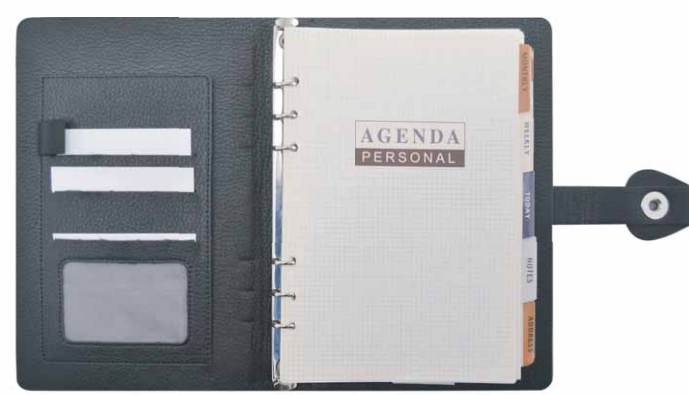

6611
 Real Leather A5 Organizer

MP 876
 Metal Ball Pen with Stripe
 on body part Black/Silver



PB 1022

SANTHOMÉ
 GENUINE LEATHER

**Santhome
Gift Sets**

FO 3251 + MP 677



PB 1022

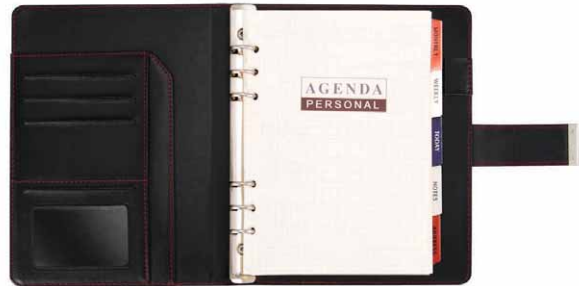

FO 3251
Organizer 8.5"(A5)



MP 677
Striped Metal Pen



FO 3301 + UD 762



PB 1022



FO 3301
8.5" Organizer
Sophisticated black/black
combination.



UD 762
Available in 2 GB, 4 GB
and 8 GB. Original SAMSUNG
memory chip is used in this
flash memory USB stick.



SANTHOMÉ



Ready Stock

6606



PB 1023



6606

A4 Cow folder with a blue leather patch, grants elegance to the otherwise all - black look.

Leather: Cow with smooth softy - touch

6606 + MP 856 + UD 745



PB 1024



MP 856

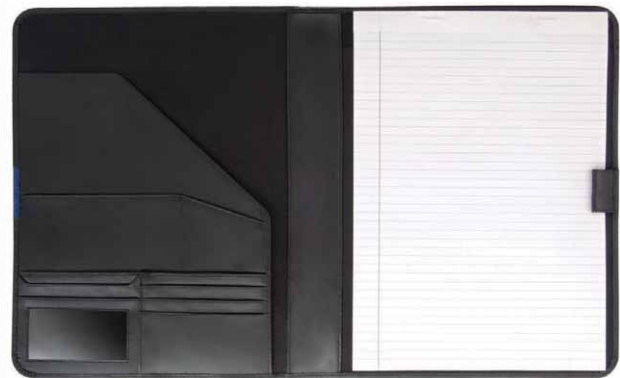

6606



UD 745

Available in 2 GB, 4 GB, 8 GB, 16 GB & 32 GB. Original SAMSUNG memory chip is used in this flash memory USB stick.

Ready Stock

6606 + MP 856 + UD 745

Set of A4 leather folder, USB flash memory drive & Blue pen (to compliment the blue leather patch on folder).

Leather: Cow with smooth softy - touch

SANTHOME
 GENUINE LEATHER

**Santhome
Real Leather Folders**

**Ready
Stock**

6605 Navy



PB 1023



6605 Navy

Black & Navy Blue leather options available

Leather: Cow with smooth softy - touch

6605 Black



PB 1023

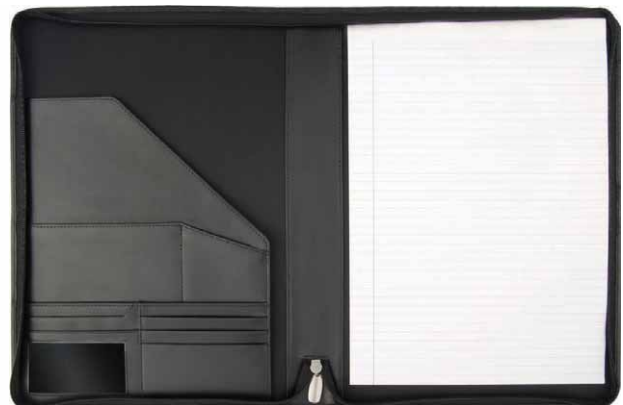

6605 Black

**Ready
Stock**

SANTHOMÉ
GENUINE LEATHER



1217 + 6021



PB 1018



1217

6021

Open & detailed image of this men's wallet can be observed on page 249

Option of 2 models of HIS - & - HER gift sets - Ladies Wallet & Men's Wallet elegantly brought together in a luxury SANTHOMÉ gift packaging!

Leather: Cow fine milled nappa

Contrast stitching and color available



Black



Maroon

15316 + 6021



PB 1018

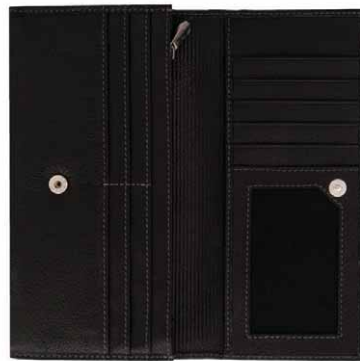

15316

6021

Open & detailed image of this men's wallet can be observed on page 249

Leather: Cow fine milled nappa

SANTHOMÉ
 GENUINE LEATHER

Santhome
Ladies Gift Sets

1218 + 6400



Ready Stock

BALMAIN
PARIS



6400

1218

Open & detailed image of this ladies wallet can be observed on page 247

PB 1018

1218 + 6400

Gift set for ladies, comprises of cow fine milled leather lady wallet with a BALMAIN Paris mobile phone case.

SANTHOME
GENUINE LEATHER

SP 303 + UD 745 Black



Ready Stock

SP 303



UD 745

Available in 2 GB, 4 GB, 8 GB, 16 GB & 32 GB. Original SAMSUNG memory chip is used in this flash memory USB stick.

PB 1012

SP 303 + UD 745 Black

Gift Sets for ladies

Comprises of ladies pen (with SWAROVSKI elements) & an elegant USB flash memory drive.

Ready Stock

1218 + 6903



PB 1015



1218

6903

Open & detailed image of this luggage tag can be observed on page 249

Sets of ladies wallets & travel luggage tags - a lady - special!

Contrast stitching and color available.



Black



Maroon

1217 + 6903



PB 1018

Ready Stock

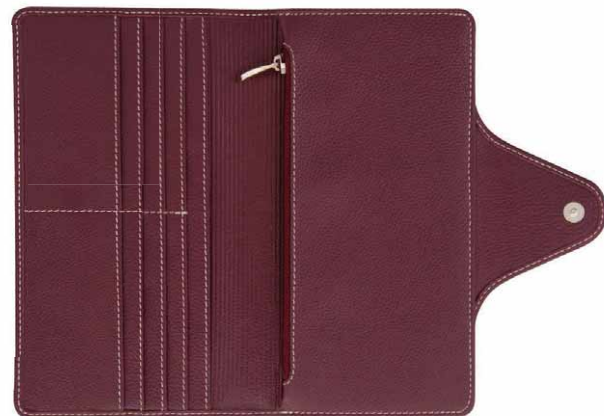

1217

6903

Open & detailed image of this luggage tag can be observed on page 249

Leather: Cow fine milled nappa

SANTHOMÉ
 GENUINE LEATHER

Santhome
 Real Leather Travel Gift Sets

1316 + 1218



PB 1020

1316 + 1218
 A lady - special! Ladies Wallet with a
 Travel Wallet

**Ready
 Stock**

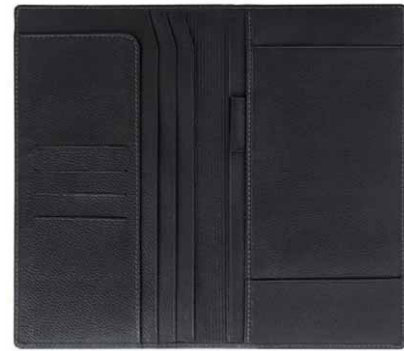

1316

1218
 Open & detailed image of this ladies
 wallet can be observed on page 247



Black with
 exotic Dark Grey
 contrast stitch.

1320 + UD 745



PB 1021

1320 + UD 745
 A travel wallet & USB flash memory
 drive set.

**Ready
 Stock**



1320



UD 745
 Available in 2 GB, 4 GB, 8 GB,
 16 GB & 32 GB. Original SAMSUNG
 memory chip is used in this
 flash memory USB stick.

SANTHOME
 GENUINE LEATHER

Leather: Cow fine milled nappa

Santhome
 Real Leather Travel Gift Sets

1305 + 6903



PB 1020

Ready Stock



1305



6903

These sets have an elegant travel wallet with a luggage tag or men's wallet - Both options come with the luxury SANTHOMÉ gift packaging
Leather: Cow fine milled nappa

Contrast stitching and color available.



Black

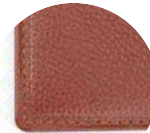

Tan

1305 + 6021



PB 1020

Ready Stock



1305



6021

Available in Black & Tan

SANTHOMÉ
 GENUINE LEATHER

Santhome
 Real Leather Cow Oil Pull-up
 Men's Wallets

6002



PB 1011



Ready Stock

6002

Wallets & Cards Case - European styles adapted to regional tastes!
 The loop closure adds to the natural elegance of these articles.

Leather: Cow oil pull - up, all - natural Italy style

A must - have for connoisseurs of quality!

Ready Stock

6004



PB 1011



6004

6003



PB 1011



6003

Ready Stock

SANTHOME
 GENUINE LEATHER

6002 + MP 870



PB 1013



6002



MP 870

**Ready
Stock**

Platignum London 1919 pen from UK with the oil pull-up leather
Wallet OR Cards case option

Leather: Cow oil pull-up, all-natural Italy style

6003 + MP 870



PB 1013



6003



MP 870

**Ready
Stock**

SANTHOME
GENUINE LEATHER

Santhome
 Real Leather
 Cow Oil Pull-up Gift Sets

6004 + 6003



PB 1015



6003

Ready Stock

The elegant oil pull-up Cards Case is paired with Men's Wallet (option of a basic wallet & a comprehensive flap wallet) in same leather.

Leather: Cow oil pull-up, all-natural Italy style.



6004



6002 + 6003



PB 1015



6003

Ready Stock



6002

SANTHOMÉ
 GENUINE LEATHER

Santhome
Real Leather Men's Wallets

Ready Stock

6006



PB 1011

Options of two models in two color combinations
Black / Grey striped - suave
The Two Brown - earthy elegance
Invisible stitch adds to the uniqueness & is a highlight of these articles.
Leather : Cow Nappa - Touched Grains



6006 Black / grey



6006 The 2 Browns

Ready Stock

6007



PB 1011



6007 Black / grey



6007 The 2 Browns

SANTHOMÉ
GENUINE LEATHER

Santhome
 Real Leather Cards Cases

Ready Stock

6005



PB 1011

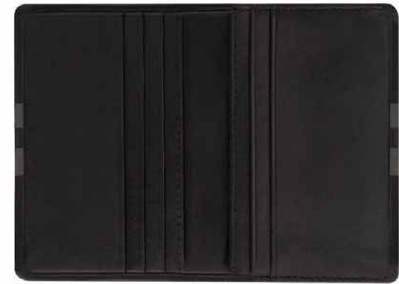

6005 Black / grey

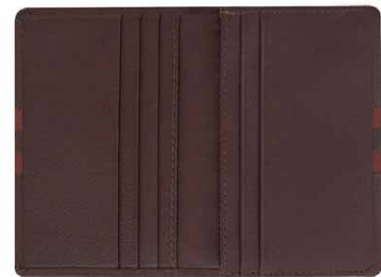

6005 The 2 Browns

Options of two models in two color combinations
 Black / Grey striped - suave
 The Two Brown - earthy elegance
 Invisible stitch adds to the uniqueness & is a highlight of these articles.

Leather : Cow Nappa - Touched Grains

6008



PB 1011

Ready Stock



6008 The 2 Browns



6008 Black/grey

SANTHOMÉ
 GENUINE LEATHER

Ready Stock

Color options available.



6302



PB 1017



6302
 Elegant loop - closed Travel
 Wallet with combination colors
 & color options.

6302 + 6006



PB 1020

Color options available.

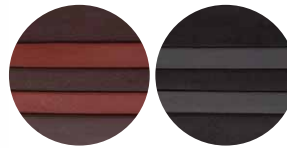

6302 + 6006
 This Travel Wallet is paired in the luxury
 SANTHOMÉ gift - set packaging with a
 matching Men's Wallet.
 Invisible stitch adds to the uniqueness
 & is a highlight of these articles.

Leather : Cow Nappa - Touched Grains

Ready Stock



6302



6006 Black / grey

SANTHOMÉ
 GENUINE LEATHER

Santhome
 Real Leather Gift Sets

6302 + UD 745 Black



PB 1021



UD 745
 Available in 2 GB, 4 GB, 8 GB,
 16 GB & 32 GB. Original SAMSUNG
 memory chip is used in this
 flash memory USB stick.



Travel Wallet options paired with
 Matching USB flash memory drive.

Leather : Cow Nappa - Touched Grains



6302
 Open & detailed image

6302 + UD 745 Brown



PB 1021



UD 745
 Available in 2 GB, 4 GB, 8 GB,
 16 GB & 32 GB. Original SAMSUNG
 memory chip is used in this
 flash memory USB stick.



SANTHOMÉ
 GENUINE LEATHER

6006 + MP 870



**Ready
Stock**

PB 1013



Platignum
LONDON 1919

MP 870
Fountain Pen



6006 The 2 Browns

Mens wallet options paired with
Platignum London 1919 pen.

Leather: Cow Nappa - Touched Grains

6006 + MP 868



**Ready
Stock**

PB 1013



Platignum
LONDON 1919

MP 868



6006 Black / grey

SANTHOME
GENUINE LEATHER

Santhome
 Real Leather Gift Sets

Ready Stock

6007 + 6008 Black/grey



PB 1015



6007 The 2 Browns

6007 + 6008
 The 2 Browns



PB 1015

6007 + 6008
 Men's Wallet & Cards
 Case Set; the black/grey
 as well as '2 brown' color
 options available.



6008

Ready Stock

Leather: Cow Nappa - Touched Grains

6007 + 6008 Black / grey
 + UD 745



PB 1019



6007 Black / grey



6008 Black/grey



UD 745
 Available in 2 GB, 4 GB, 8 GB,
 16 GB & 32 GB. Original SAMSUNG
 memory chip is used in this
 flash memory USB stick.

SANTHOMÉ
 GENUINE LEATHER

Ready Stock



6009



PB 1011



6009



Ready Stock

These Wallets & Cards Cases are edge - colored, then a matching thread stitch added to enhance the looks of an invisible - stitch leather article.

Edge - colors & threads options: Light -Grey, Red, Maroon, Royal Blue & Green

Leather: Cow Softy - Corrected Hair Cell

6010



PB 1011



6010

Ready Stock

SANTHOMÉ
 GENUINE LEATHER

**Santhome
 Real Leather Sets**

6011



PB 1011



Royal Blue Red Light - Grey Maroon Green

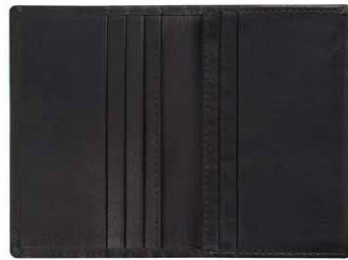

6011

Cards case, edge - colored,
 matching - thread stitched
 Edge - colors & threads options:
 Light -Grey, Red, Maroon, Royal
 Blue, Green

Leather: Cow Softy - Corrected Hair Cell

6009 Black / Grey +
 KC 2024



PB 1013



6009 Black / Grey

6009 Black / Grey +
 KC 2024
 Set of Wallet with a sim -
 pocket key holder

KC 2024



SANTHOMÉ
 GENUINE LEATHER



6009 + 6011



PB 1015



6009

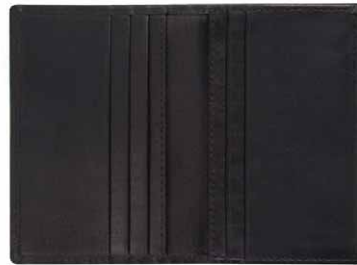

6011

Set of Wallets & Card Case - Options & Color - Combinations available as shown. The invisible - stitch leather articles are glamorous in appeal & appearance.
Leather: Cow Softy - Corrected Hair Cell

6009+ 6010



6009



6010



PB 1015

SANTHOME
 GENUINE LEATHER

Santhome
Real Leather Gift Sets

6002 + MP 862 R & B
Brown



PB 1013



6002



MP 862 R & B Brown

**Ready
Stock**

Wallets - European styles adapted to regional tastes!
The loop closure adds to the natural elegance

Leather: Cow oil pull - up, all - natural Italy style.

6004 + MP 862 R & B
Brown



PB 1013



6004



MP 862 R & B Brown

**Ready
Stock**

SANTHOMÉ
GENUINE LEATHER



Ready Stock

6007 + MP 862 R & B
Black



PB 1013



6007 Black / grey



MP 862 R & B Black

Options of two models in two colors combination.
Leather : Cow Nappa - Touched Grains

6006 + MP 862 R & B
Brown



PB 1013



6006 The 2 Browns



MP 862 R & B Brown

Ready Stock

SANTHOMÉ
GENUINE LEATHER



A - Z	PAGE NO.
@memorii USB Flash Memory Sticks / Drives	61
AUTOMOBILE ACCESSORIES	92, 94, 96, 154, 164, 165, 169-171, 214
AIRLINE GIFT	212
BAGS	
Backpacks	127, 137-139, 142, 144-145, 151, 153
Cooler bags	155
Cotton Shopping bags	159-160
Conference bags	152
Customized bags	148-155
Eco Friendly bags	156-162
Garment Bag	101
Jute Shopping bags	156-158
Laptop & Tablet Bags / Cases	124 - 130, 133, 135-139, 142, 145, 153, 158
Messenger bags	125, 133, 153
Non Woven Shopping bags	161
Office bags	129, 228
Prayer mat bags	148
School bags	151
Shopping bags	156 - 162
Shoulder bags	136 - 150
Sports bags	132 - 134, 139, 149, 154
String bags	155
Travel bags	143, 146 - 147, 149
Trolley bags	101, 107, 131, 140-141, 143
BALMAIN	
Folders	110
Gift Sets	222 - 223
Ladies Mobile Phone Case	188
Office Bags	129
Pens	68 - 70
Umbrella	50
BLANKET	173
BUSINESS CARD HOLDERS & CREDIT CARD HOLDERS	61, 123, 176 - 178, 218, 239, 250, 254, 259 - 260
CALCULATORS	181
CAPS	20 - 24
CAR REQUISITES	92, 94, 96, 154, 164, 165, 169-171, 214
CD HOLDER/CASE	101, 152, 218
CLOCKS	197 - 200, 202- 203, 210-211, 213 - 217, 219
COASTERS	220
COFFEE SETS	94 - 95
COUNTDOWN TIME CLOCK	173
COVERALLS	30 - 40
CSR - Little Steps	86 - 87
CUSTOMIZED ITEMS:	
Bags	148 - 155
Coveralls & Workwear	30 - 40, 46 - 47
Diaries	172
Polo Shirts	25 - 29
Promoclips	163
Sporting Goods	186 - 187
Sportswear	42 - 44
Uniforms	41, 45-47
Winter-Wear	48 - 49
DESKTOPS & DESKSETS	52, 56-59, 196 -197, 200-219
DIARIES	172
DRINKWARE	88 - 97, 99-100
DRY N COOL	
Polo Shirts	8-12
Caps	20 - 21



A - Z

PAGE NO.

ECO-FRIENDLY GIFTS/ARTICLES	
Bags	127, 156-162
Bio Bottles	88 - 89
IT	52, 53, 55, 56
Leather	85
Pens	79, 83
Toys & Games	86 - 87
econeutral	
Folders, Organisers, Stationeries	84, 122-123
Pens	79
Shopping Bags	156 -162
Stationeries & Real Leather Articles	84-85, 122-123
FOLDERS	110-118, 122-123, 228-229
FOOTBALL RELATED ARTICLES	44, 81, 100, 166, 186
GIFT SETS	167, 195, 221-263
GIORDANO SHIRTS	7
GOLF ACCESSORIES & SHIRTS	184-185, 218
i Health for wellness	109
HANS LARSEN	
Caps	22 - 24
Mugs/Drinkware	94, 96, 97
ISLAMIC GIFTS	148
IT GADGETS / ACCESSORIES	52 - 65, 75
KEYHOLDERS	50, 164-166
LADY GIFTS	188-190, 235-236, 246-247
LAMBORGHINI	
Belts	50
CD Holder/Case	101, 218
Gift Sets	222, 224-225
Leather	50
Office	101
Pens	71
Shirts & Polos	6
Silver	218-219
Travel	101
Watches	51
LANYARDS	168
LAPTOP TABLET BAGS / CASES	124-130, 133, 135-139, 142, 145, 153, 158
LEATHER ARTICLES (GENUINE LEATHER)	
Bags & Briefcases	228
Credit Cards Cases	178, 239, 254, 259-260
Folders & Organisers	85, 111, 121, 229
Gift Sets	190-192, 222, 224-263
Keyholders	50, 164-165
Ladies Wallet	188-189, 236
Men's Articles	50, 85, 191-193, 237-238, 250, 253, 259
Mobile Phone Cases	226
Passport Covers	85, 193, 235, 239
Shoe Requisites Kit	227
Sim Holders	193, 239
Travel Wallets & Luggage Tags	102-103, 227, 255
MEN'S WALLETS	85, 191-194, 237, 250, 253, 259
MISCELLANEOUS ITEMS	173
MOUSE PADS	167, 219
MUGS	93, 94, 96, 97, 100
ORGANISERS	118-123
OUTDOORS	50, 98, 108, 181-184
PENS	66-83
KITCHENWARE	53, 94, -95, 98-99

Glossary

A - Z

PAGE NO.

PGA TOUR BBQ SET & GOLF SHIRTS	184
PHOTOFRAMES	197, 208-210
PLASTIC PENS	77-83
PLATIGNUM PENS FROM U.K.	66
POWER BANKS & CHARGERS	52-56
POLO SHIRTS	4-6, 8-15, 25-29
POCKET NOTEPADS	177, 226
PROMOCLIPS - Made in The Netherlands	163
SANTHOME	
Caps	20- 21
GiftSets	221, 226-263
Laptop Bags & Backpacks	124-130, 133, 136-145
Leather Gifts	226-263
Pens	72 - 75
Polo Shirts	8-15
Ties (Neck)	18-19
Travel Adapter	104-105
SHIRTS	6-7, 45
SILVER PLATED ARTICLES	210, 218-219
SLAZENGER	
Backpack & Laptop Bags	135
Caps	20
Drinkware	91
Polo Shirts	5
Sports Bag	134
Sunglasses	50
Watches	50
SOLAR CHARGERS	52-53, 55-56
SPEAKERS	59
SPORTING GOODS	184 - 187
SPORTS BAGS	132-134,139,149,154
STRESS RELIEVERS	166
SUNSHADES	169
SWAROVSKI ELEMENTS (IN PEN)	75
SWISS PEAK TRAVEL ACCESSORIES	107, 179
SWEATER	4
T-SHIRTS	16, 17
TACX BIO-BOTTLES	88 - 89
TIES (NECK)	18 - 19
TOOLS & TORCHES	170 - 171, 179-183, 196
TRAVEL ACCESSORIES / GADGETS	53 - 55, 104-106
TRAVEL BAGS	143, 146, 147, 149,
TRAVEL WALLETS & LUGGAGE TAGS	102-103, 107, 227, 255
TROLLEY BAGS	101, 107
TROPHIES & AWARDS	213
TSA LOCKS	106
UMA PENS FROM GERMANY	80 - 83
USB FLASH MEMORY STICKS / DRIVES	60 - 65
WALL CLOCKS	198 - 199
WATCHES	50 -51
WEATHER STATION	211
WHEEL COVERS	154
YOGA ARTICLES - WELLNESS	108
XDDESIGN	
AUTOMOBILE ARTICLES	92, 170-171
DRINKWARE	90-93, 95, 99
LIFE STYLE	174
PENS	67
SAFETY	175
SOLAR CHARGERS	52, 53, 56
STATIONERIES	173
TOOLS	183



When one gifts...

1. The Giver is making a statement...
 I have class, & my gift reflects my class.
 I have taste; it shows in my gift!
2. The Giver is expressing...
 Please accept this as a token of our appreciation, for patronising us & our organization.
3. As & when the receiver uses the gift he remembers the giver - the bond becomes stronger subconsciously.
4. It is important to remember an advertisement giveaway is meant to serve a different purpose than a gratitude gift. The branding is done accordingly.

We will spoil you for choice !

our range & our stocks are the largest in the Middle East & Africa.

We are experts in this business & can help you select & brand your gifts appropriately.



Available in this catalogue

CORPORATE GIFTS  by *Tonino Lamborghini* **BALMAIN** PARIS **SANTHOME**

@MEMORII **XDDESIGN®** **Platignum** LONDON 1919

 Little Steps® **eco-neutral** *Hans Larsen*

  **GIORDANO**

 **SWISS PEAK®** **Tacx** BIO BOTTLES MADE IN THE NETHERLANDS **UMQ** PENS FROM GERMANY

